

inventronics

## Technical application guide

DALI PROFESSIONAL 3  
Commissioning Software

# 1 Table of Contents

<b>1</b>	<b>Table of Contents</b> .....	<b>2</b>
<b>2</b>	<b>Introduction</b> .....	<b>7</b>
2.1	Overview of the DALI PRO 2 IoT lighting controller .....	8
2.1.1	LED indicators .....	9
2.1.2	User Buttons.....	10
2.2	Installation .....	10
2.3	Wiring Diagram.....	11
2.4	On-Site Check .....	11
2.5	Connecting to the DALI PRO 2 IoT Controller .....	11
2.6	Functions and limitations of the DALI PRO Controller:.....	13
2.7	Installing the software .....	15
2.8	Tools required .....	15
<b>3</b>	<b>First steps</b> .....	<b>16</b>
3.1	Overview of commissioning the software .....	16
3.2	Device Tree.....	17
3.2.1	ECGs .....	17
3.2.2	Coupler .....	18
3.3	Connection of functions in the graphical view .....	19
3.4	Create a new configuration/ project.....	20
3.4.1	Establishing a connection to the controller .....	20
3.5	New Project / Project Features.....	24
3.5.1	Search for DALI devices .....	25
3.5.2	Linking DALI devices via functions.....	32
3.5.3	Upload configuration.....	35
<b>4</b>	<b>Basic functions</b> .....	<b>36</b>
4.1	ECG Groups.....	36
4.2	Creation of button functions .....	38
4.2.1	Direct actions.....	38
4.2.2	Switches.....	42
4.2.3	Time-delayed actions.....	43
4.2.4	Create light scenes.....	44
4.2.5	Central control function.....	46
4.2.6	Overlapping groups .....	46

- 4.3 Motion detection .....48
  - 4.3.1 Functionality .....48
  - 4.3.2 Push button and motion detection .....49
  - 4.3.3 Lock motion detection via button, time functions, sequence control .....50
  - 4.3.4 Lock motion detection via switch .....51
- 4.4 Light control .....52
  - 4.4.1 Parameters .....52
  - 4.4.2 Calibration .....52
  - 4.4.3 Automatic light "ON" and "OFF" switching .....54
  - 4.4.4 Control with multiple sensors .....55
  - 4.4.5 Regulation and offset groups .....56
  - 4.4.6 Dynamic change of regulation value .....56
  - 4.4.7 Twilight function .....57
- 5 Color Control (RGB/W) .....59**
  - 5.1 General .....59
  - 5.2 Add RGB/W device and configure basic settings .....59
    - 5.2.1 Adding RGB/W device .....59
    - 5.2.2 Using RGB/W in the application .....61
  - 5.3 Add and configure buttons .....62
    - 5.3.1 Adding buttons .....62
    - 5.3.2 General settings .....63
    - 5.3.3 Delayed action configuration options .....63
    - 5.3.4 Short push actions .....63
    - 5.3.5 Long push actions .....63
    - 5.3.6 Double push actions .....64
    - 5.3.7 Setting a color value .....64
  - 5.4 Add and configure a colored scene .....64
    - 5.4.1 Adding a colored scene .....65
    - 5.4.2 Configuring a colored scene .....65
    - 5.4.3 Recalling a scene .....66
    - 5.4.4 Recalling multiple scenes .....67
  - 5.5 Add and configure a Color Effect (RGB/W profile) .....67
    - 5.5.1 Generating an RGB/W profile .....67
    - 5.5.2 Selecting a button function for the RGB/W profile .....68
    - 5.5.3 Configure an RGB/W profile .....68
    - 5.5.4 Defining color profiles .....70
- 6 Tunable White .....72**
  - 6.1 General .....72
  - 6.2 Adding a Tuneable White (TW) device and configuring basic settings .....72
    - 6.2.1 Generating combined Tunable white lamps .....72

- 6.2.2 DALI device type color (8-TW) ..... 74
- 6.3 Configuring the TW device ..... 76
  - 6.3.1 Configuration settings ..... 77
- 6.4 Add and configure buttons ..... 78
  - 6.4.1 General settings ..... 78
  - 6.4.2 Delayed action configuration options ..... 79
  - 6.4.3 Short Push actions ..... 79
  - 6.4.4 Long Push actions ..... 79
  - 6.4.5 Double Push actions ..... 79
  - 6.4.6 Special function double light ..... 79
  - 6.4.7 Configuring a button for multiple TW devices ..... 80
- 6.5 Add and configure a TW scene ..... 80
  - 6.5.1 Adding a TW scene ..... 80
  - 6.5.2 Configuring a TW scene ..... 81
- 7 Advanced features- Effect ..... 81**
  - 7.1 Using an effect ..... 81
  - 7.2 Effect: "Lighting Profile" ..... 82
  - 7.3 Effect: RGB(W) Profiles ..... 83
    - 7.3.1 Mode Configuration ..... 83
    - 7.3.2 Multiple effect profiles (for experienced users) ..... 83
    - 7.3.3 Effect Control Functions ..... 84
  - 7.4 Lighting Profile: Daylight simulation ..... 87
    - 7.4.1 Configure a daylight simulation ..... 87
    - 7.4.2 The lighting profile editor ..... 88
    - 7.4.3 Configuring and Managing lighting profiles ..... 89
    - 7.4.4 Starting and Stopping Daylight Simulation ..... 92
  - 7.5 Lighting Profile: RGB Sequence ..... 95
    - 7.5.1 The RGB sequence editor ..... 95
    - 7.5.2 Configuring and Managing RGB(W) Sequences ..... 96
  - 7.6 Fade ..... 97
- 8 Advanced Features- Timer ..... 98**
  - 8.1.1 Time Switch ..... 99
- 9 Advanced Features- App configurator ..... 100**
  - 9.1 General Requirements ..... 100
    - 9.1.1 Prerequisites: ..... 100
  - 9.2 Features ..... 101
  - 9.3 Configuring the APP ..... 102
    - 9.3.1 Defining the views ..... 102
    - 9.3.2 APP elements ..... 103
    - 9.3.3 Define user profiles ..... 108

<b>10</b>	<b>Advanced Features- Zone Separator</b>	<b>110</b>
10.1	Basic Rules	110
10.2	Situation: Two Parts with One Door	110
10.3	Synchronization with Door State Changes	111
10.3.1	Situation: More Than One Door (Two or Three)	112
<b>11</b>	<b>Advanced Features- Step Sequencer</b>	<b>113</b>
11.1	Representation of Sequences in the Graph View	113
11.2	Creating sequences	114
11.3	Logic Functions in Sequences	116
11.3.1	Logic Functions for a Simple Swarm Function	116
11.3.2	Step sequencer and relay	118
11.3.3	Lock/Unlock Motion Detection for Step Sequencer	119
<b>12</b>	<b>Virtual wiring (LAN Interconnection)</b>	<b>120</b>
12.1	General	120
12.1.1	Commissioning Process	120
12.1.2	Key Considerations for virtual wiring	120
12.1.3	LAN (IP address) setup	121
12.2	Example: Virtual wiring for a button	121
12.3	Virtual wiring between the controllers (For DALI PRO 2 IoT)	124
12.3.1	Notes	127
12.4	More functions	128
12.4.1	LAN connection for motion detection	128
12.4.2	LAN connection for switch	129
12.5	LAN Test Functions	130
12.6	Auto generation or import of inputs and outputs	131
<b>13</b>	<b>Emergency Light</b>	<b>133</b>
13.1	State	133
13.1.1	Inhibit Mode	134
13.2	Test Configuration	135
13.3	Email configuration	136
<b>14</b>	<b>Test Functions</b>	<b>136</b>
14.1	Group light status	136
14.2	ECG	137
14.3	ECG lamp failure dialog	138
14.4	Device service functions	139
14.5	Coupler check	140
14.6	Check of light sensors	140
14.7	Event Monitor	141
<b>15</b>	<b>DALI SPY</b>	<b>141</b>

- 15.1 DALI Spy panel ..... 141
  - 15.1.1 Button bar ..... 142
  - 15.1.2 Information line..... 142
  - 15.1.3 Display Area..... 143
- 15.2 Spy Options..... 144
  - 15.2.1 Columns..... 144
  - 15.2.2 Filter..... 145
- 16 Appendix ..... 146**
  - 16.1 Create a diagnose file..... 146
  - 16.2 Device Feature ..... 146
  - 16.3 Set controller back to plug & play mode..... 147
  - 16.4 Remote Access ..... 148
  - 16.5 API ..... 148

## 2 Introduction

This document provides step-by-step instructions for commissioning the DALI Professional (DALI PRO) system. The DALI PRO system is a lighting control system based on the standardized DALI system according to IEC 62386 ([www.dali-alliance.org](http://www.dali-alliance.org)) and allows the setup of a flexible, addressable digital lighting control system. The central component is the DALI PRO Controller, available in versions with 2 (DALI PRO 2 IoT) or 4 (DALI PRO CON 4 RTC) DALI lines. DALI ECGs (e.g., LED Drivers, Ballasts, or Dimmers) and DALI input devices (e.g., light and motion sensors, push buttons) can be connected to these DALI lines.

The DALI PRO controllers offer advanced features like automated energy-saving modes, multi-zone light regulation, scene management, TW and RGBW support. Multiple controllers can be interconnected via LAN to expand the system capabilities, while integration to a KNX installation is also possible. The Windows-based DALI PROFESSIONAL 3 Commissioning Software ("PC Tool") enables the convenient setup and visualization of individual configurations for the DALI PRO system. Complete configurations can be displayed on the screen and adjusted with a click of the mouse. Changes in the project configuration are transferred from the PC to the controller via LAN connection, Wi-Fi (DALI PRO 2 IoT only), or USB (DALI PRO CON 4 RTC only). The PC Tool offers many configuration options, which are described in detail in the following pages.

A dedicated UI for the DALI PRO CON 4 RTC can be found here: [Dali Professional – Inventronics](#). On this document we shall focus more on the DALI PRO 2 IoT controller.

## 2.1 Overview of the DALI PRO 2 IoT lighting controller

The DALI PRO 2 IoT controller is a feature-rich, two-channel DALI-2 controller. It boasts an intuitive browser-based graphical user interface for easy commissioning and comes with a built-in gateway that connects to the cloud, enabling IoT applications.

There are two methods for commissioning the DALI PRO 2 IoT controller: the first is through locally run graphical user interface (WebUI). More info on this method can be found on the Quick Start Guide ([Dali Pro 2 IoT – Inventronics](#)). The second method is via the the PC Tool, a Windows-based software, which can be installed on your personal computer. You can find this tool available here: [Dali Pro 2 IoT - Inventronics \(inventronics-light.com\)](#). This guide will cover the latter approach.

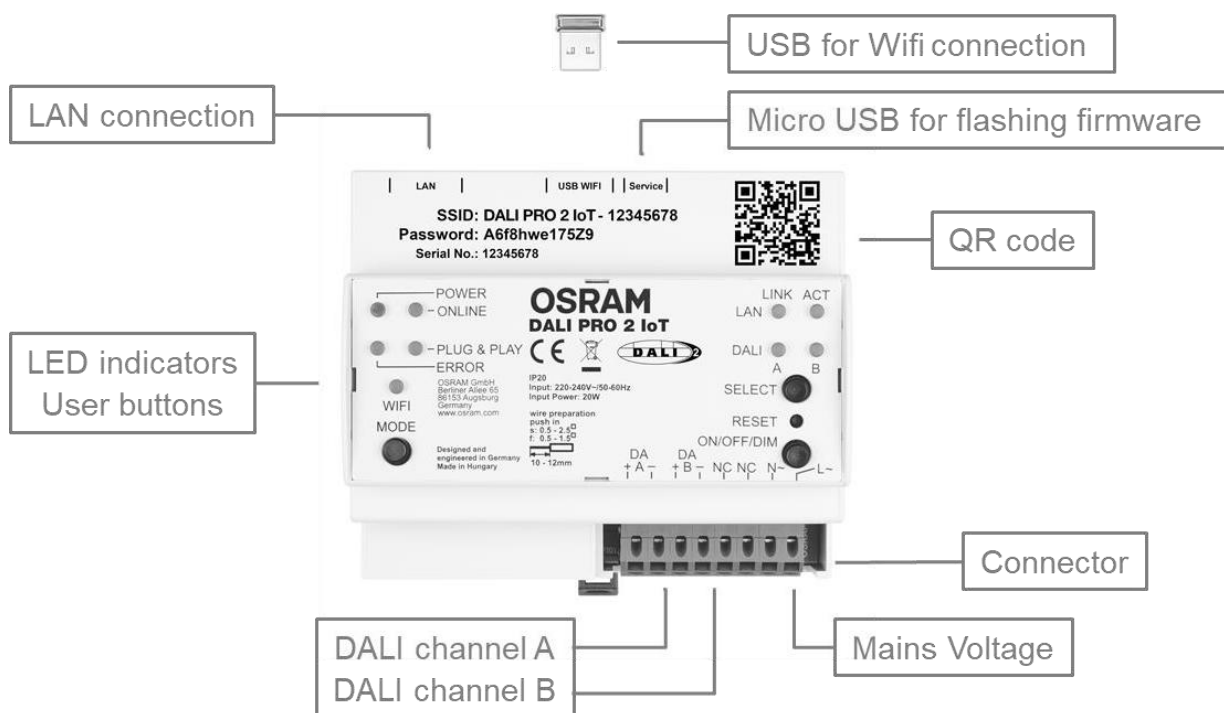

The USB Wi-Fi dongle is included in the package and must be inserted by the user. The micro-USB connector is used for flashing firmware (for manufacturer use only).

The controller provides status information through colored LED indicators and allows users to configure settings using user buttons.



### LED Indicators

### User Buttons



#### 2.1.1 LED indicators

##### POWER

LED = on mains voltage is present, controller is operational

##### ONLINE

LED = on controller is connected to the OSRAM cloud

##### WIFI

LED = on WIFI connection is activated

LED = flashing WIFI connection is being activated (booting)

##### LAN LINK

LED = flashing Indicates data traffic

##### LAN ACT

LED = on LAN is active

##### DALI A

LED = on DALI voltage is present

LED = flashing DALI line is too low, voltage = 0V

LED = sparking DALI line is too high, voltage > 20V

##### DALI B

LED = on DALI line voltage is present

LED = flashing DALI line is too low, voltage = 0V

LED = sparking DALI line is too high, voltage > 20V

##### PLUG & PLAY

LED = on Controller is not programmed yet, Plug & Play option available

##### ERROR

LED = on Error detected

## 2.1.2 User Buttons

<b>MODE</b>	switches on/off the Wi-Fi (toggle function)
<b>SELECT</b>	selects DALI channel “A” or DALI channel “B” or both (toggle function)
<b>RESET</b>	short press (min. 5 seconds) = a reset as in power cycle long press (min. 15 seconds) = re-boot the system
<b>ON/OFF/DIM</b>	toggles through on-off-dim functions for the selected channel(s)

## 2.2 Installation

The DALI Pro 2 IoT controller is to be mounted on a 35 mm DIN rail inside a switch cabinet as per DIN 43880 requiring a width of 6 horizontal pitch units.

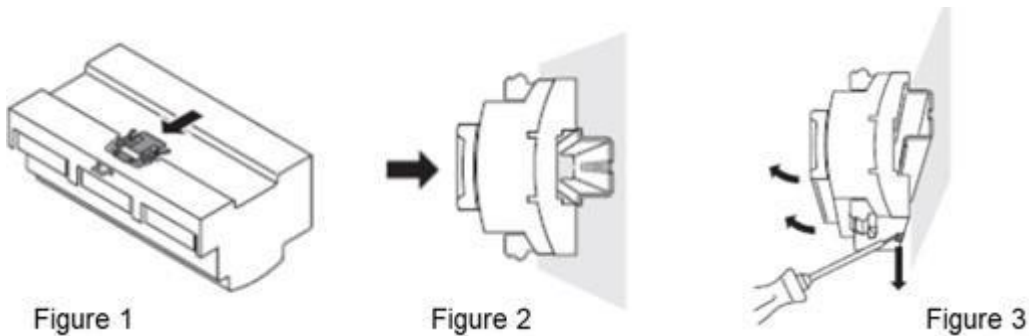

### Mounting the controller on a DIN rail

Figure 1: press in the lock clip until you hear a click sound.

Figure 2: lock in the controller on the DIN rail.

### Removing the controller from a DIN rail

Figure 3: push out the lock clip by using a screwdriver

### 2.3 Wiring Diagram

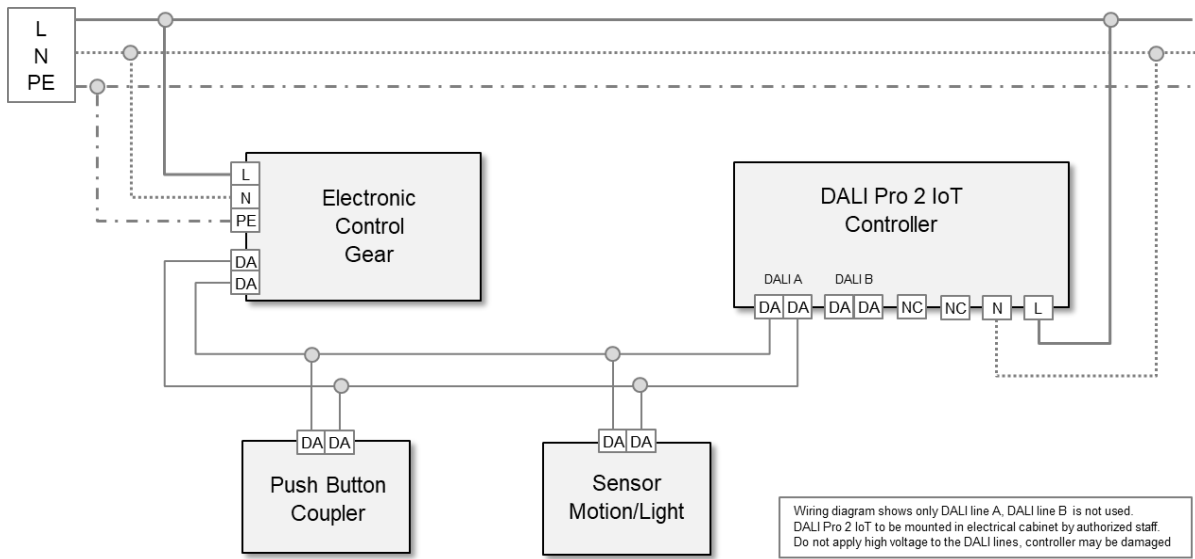

### 2.4 On-Site Check

When main voltage is applied, the controller's POWER LED will illuminate. Please allow for a 2-minute booting process for the internal micro-controller and Wi-Fi connection.

If the controller hasn't been programmed yet, the Plug & Play LED will activate, and you can test the functionality of the luminaires by toggling the ON/OFF/DIM button, which will broadcast the corresponding commands. Additionally, you can individually check channels A or B

### 2.5 Connecting to the DALI PRO 2 IoT Controller

The USB Wi-Fi dongle (included) must be placed in the controller's USB slot and activated by the MODE button. If activated, the Wi-Fi LED will light up. Wi-Fi mode will give the user access to the browser-based commissioning interface.

The information required to connect to the Wi-Fi network is printed on the controller:



The LED above the button lights up constantly to indicate that the WLAN is ready for use and appears in the list of available WLANs. The network or SSID name, which is also printed on the device, begins with "DALIPro2-" and contains the serial number of the device:

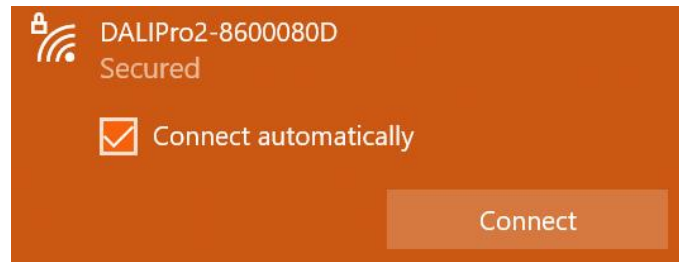

If you are prompted to enter a PIN, the entry must be changed by clicking on "Connection using a network security key instead"

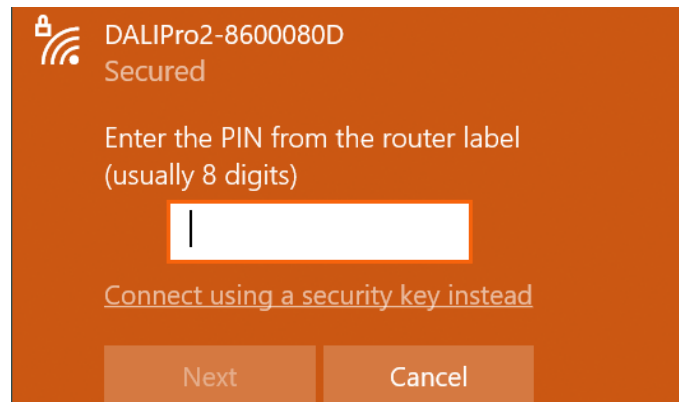

The password printed on the device can then be entered here. In the example above: A6f8hwe175Z9

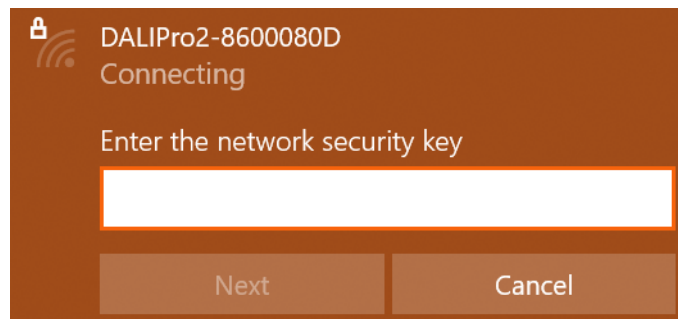

As this is only a local WLAN, it is pointed out after the connection is established that no Internet is available.

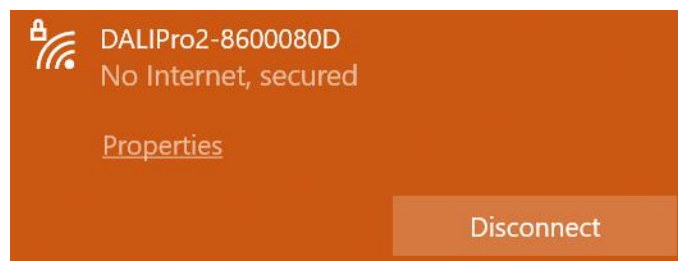

## 2.6 Functions and limitations of the DALI PRO Controller:

- 2 x 64 (DALI PRO 2 IoT) or 4 x 64 (DALI PRO CON 4 RTC) DALI addresses for control gear, as well as 2 x 64 and 4 x 64 addresses for control devices
- 2 x 16+ groups (DALI PRO 2 IoT) or 4 x 16+ groups (DALI PRO CON 4 RTC), possible across multiple lines. ("+" means that additional virtual extensions of the DALI groups can be created using software. Individual addresses are managed, this is only limited by the memory space in the controller)
- 2 x 16 scenes (DALI PRO 2 IoT) or 4 x 16 scenes (DALI PRO CON 4 RTC), line overlapping allowed, but then one scene used for each line.
- 2 x 8 (DALI PRO 2 IoT) or 4 x 8 (DALI PRO CON 4 RTC) active light regulation, a larger number is possible if delayed response times are accepted.
- Up to 8 x DALI PRO 2 IoT or 4 x DALI PRO CON 4 RTC controllers (1024 DALI addresses in total) can be interconnected via LAN and operate as one system
- Energy-saving function in fully and semi-automatic mode with presence detector and light sensor
- Up to 12 light sensors / sensor couplers/ push button couplers (PBC). The total number depends on overall number of DALI devices per DALI line (see table 1)

### DALI PROFESSIONAL System design guidelines

Maximum number of ECG's per DALI line depending on combination of sensor- and push button coupler														
ECG	Number of DALI sensor coupler													
	0	1	2	3	4	5	6	7	8	9	10	11	12	
Number of DALI push button coupler	0	64	64	64	64	64	64	64	64	64	64	64	64	64
	1	64	64	64	64	64	64	64	64	64	64	64	64	64
	2	64	64	64	64	64	64	64	64	64	64	64	64	64
	3	64	64	64	64	64	64	64	64	64	64	64	63	61
	4	64	64	64	64	64	64	64	64	64	64	63	60	58
	5	64	64	64	64	64	64	64	64	64	62	60	57	55
	6	64	64	64	64	64	64	64	64	62	59	57	54	52
	7	64	64	64	64	64	64	64	61	59	56	54	51	49
	8	64	64	64	64	64	63	61	58	56	53	51	48	46
	9	64	64	64	64	63	60	58	55	53	50	48	45	43
	10	64	64	64	62	60	57	55	52	50	47	45	42	40
	11	64	64	62	59	57	54	52	49	47	44			
	12	64	61	59	56	54	51	49	46	44				
	13	61	58	56	53	51	48	46						
	14	58	55	53	50	48								
	15	55	52	50										
	16	52												

Power consumption of DALI device:  
 ECG: 2 mA per device  
 Sensors & coupler: 5-6 mA per device

This is a factory recommendation to ensure the functionality of the system at all times. However, these are not absolute numbers that can be exceeded in individual cases, as long as they do not limit the addressing guideline of the DALI standard. (64 Addr.) In the example, we recommend connecting only 60 ECGs when using 5 sensor couplers and 9 pushbutton couplers at the same time.

This list is based on a calculation of both the current consumption and the data stream within the bus line and therefore represents a stable and reliable empirical value. **We strongly recommend adhering to these values.**

- Corridor function with two reduction steps.
  - Motion sensor can be switched on/off
  - Sequences consisting of scenes, fade times, program sequences
  - Display of the resource status
  - Serial/parallel configuration of grouped switches
  - 4 programmable internal relays (only DALI PRO CON 4 RTC)
  - Test function for all DALI devices
  - Automatic testing and reporting of DALI emergency control gear (DT1) (only DALI PRO 2 IoT)
  - Remote Access service for reconfiguration (only DALI PRO 2 IoT)
  - Failure notifications and summary table (only DALI PRO 2 IoT)
  - REST/ MQTT API (only DALI PRO 2 IoT)
  - Complete project documentation as HTML file
  - Up to 50 different time-based functions can be configured
  - Support of all OSRAM/ Inventronics sensors/ couplers
  - Support of DALI-2 devices described in parts 301-304 of IEC 62386 (DALI PRO 2 IoT only):
    - push- buttons (Part 301)
    - switches and sliders (Part 302)
    - occupancy sensors (Part 303)
    - light sensors (Part 304)
  - Interconnection of up to 8 DALI PRO 2 IoT or 4 DALI PRO CON 4 RTC via LAN is possible.
- NOTE:** a combination of DALI PRO 2 IoT and DALI PRO CON 4 RTC by using the interconnect functionality is not possible!
- It's possible to have both device types in one network.

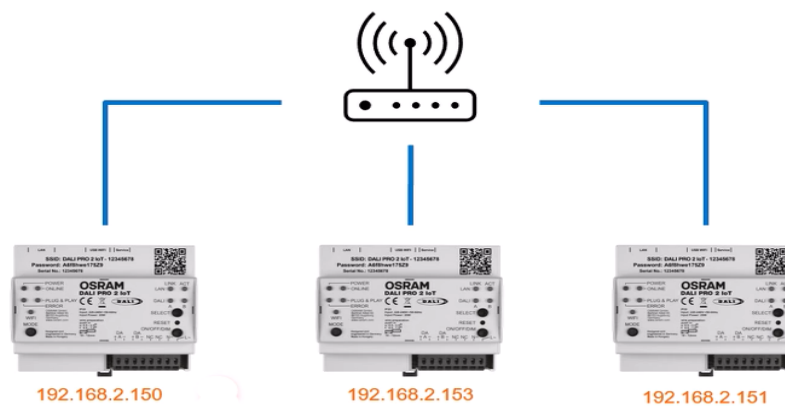

Tip !

Note down the **IP addresses** as given by the router

## 2.7 Installing the software

- Download the DALI PROFESSIONAL 3 software (PC Tool) from: [Dali Pro 2 IoT - Inventronics \(inventronics-light.com\)](http://inventronics-light.com/Dali_Pro_2_IoT)
- Extract the .zip file
- Install the DALI PRO system software by starting 'DaliProfessional\_Installer v3\_x\_x\_x.msi'. The default location of the program is: 'C:\Program Files (x86)\Inventronics\DALI Professional 3'
- Establish a connection between the controller and the PC by one of the following methods:
  - Connecting both the PC and the DALI PRO Controller to the same LAN network
  - Using the controller's internal Wi-Fi network (available only for the DALI PRO 2 IoT)
  - Connecting via USB (available only for the DALI PRO CON 4 RTC)
- Start the program with the desktop icon or via Start / Programs / Inventronics / DALI PRO
- Supported Windows versions: Windows 7, Windows 10, Windows 11

## 2.8 Tools required

- The following tools are recommended for commissioning the DALI PRO.
- The equipment should include at least the following:
  - Commissioning PC
  - Network equipment: WLAN router or wired router with ethernet cable.
  - For DALI PRO CON 4 RTC, USB connection cable (USB-A to USB-B 2.0 Cable) between PC and controller.
  - Lux meter: the light meter should be able to measure light values in lux
  - Measuring tape
  - Flashlight
  - List of Dali PRO system components to be configured

## 3 First steps

### 3.1 Overview of commissioning the software

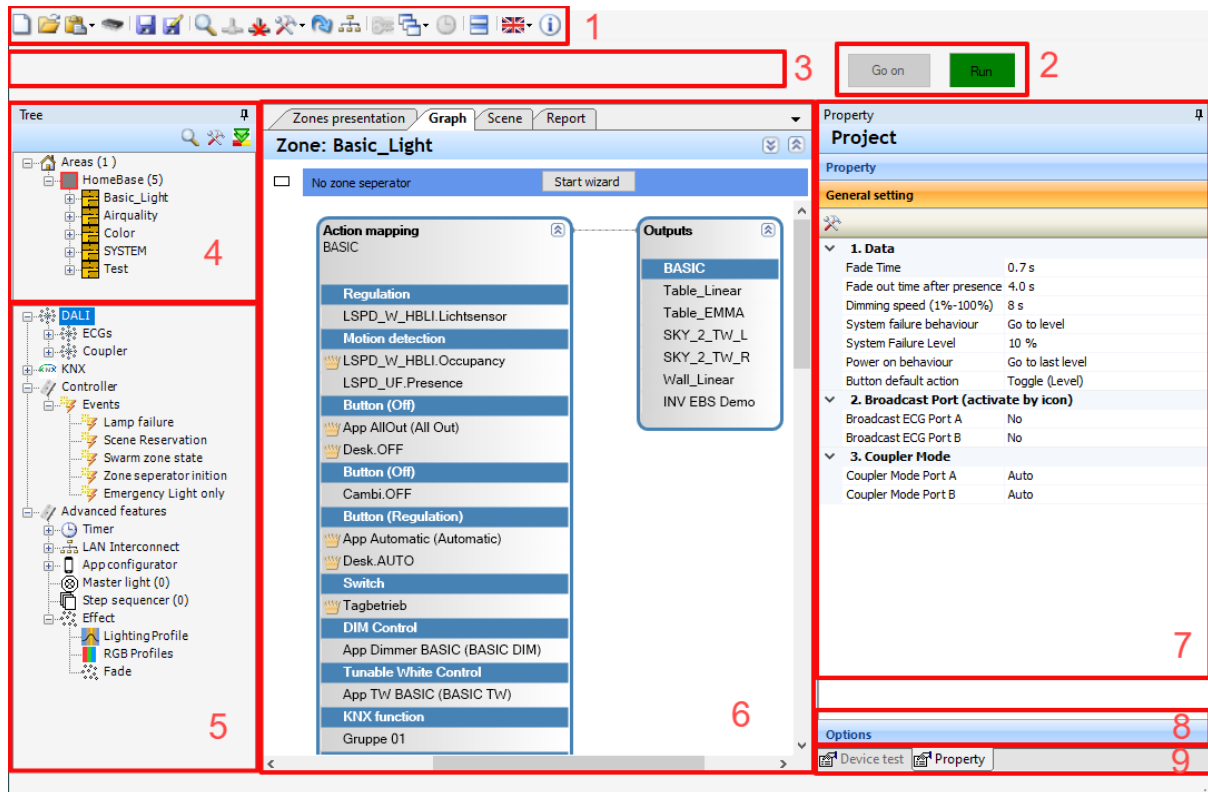

#### Quick access toolbar (1)

The main functions are listed in the quick access toolbar.

#### Operating status (2)

While test functions are running or after searching for devices, the status of the controller is on hold. Once the tests have been completed, the Go On button can be used to set the controller to its normal state.

#### Notification area (3)

Error messages and notes are displayed in this area.

#### Zone area (4)

The zone area is used to group functions. This enables a better overview in larger projects or simpler pre-commissioning.

#### Device view (Tree) (5)

In addition to the single drivers, the groups of drivers are also displayed in the device view. These groups are created automatically by moving the driver in the graphical view. The functions are created by connecting them to inputs.

#### Graphic Panel (6)

The graphic panel area is used to create lighting groups and link input with output devices,



simply by dragging and dropping them from the device view to it.

## Properties (7)

All available information for the selected device is displayed in the properties window and can be changed.

## 3.2 Device Tree

### 3.2.1 ECGs

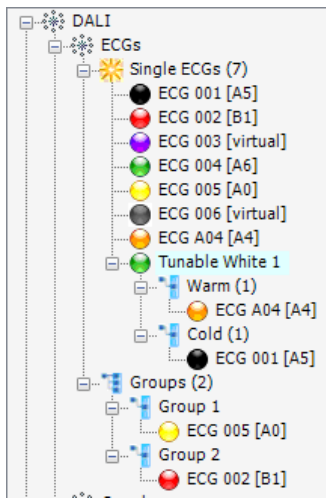

In the device tree, all ECGs and ECG groups will be listed. ECG groups are automatically generated when an ECG is moved to the graph panel and functions are created by connecting them with inputs.

It is also possible to create groups manually, such as using the localization dialog. Existing groups can be reused, and their titles can be changed.

These groups are not equivalent to DALI groups and can contain ECGs from different DALI ports. DALI groups are assigned dynamically during the upload process.

The color on the driver shows the current status:

Color	Status	Remark
	Deactivated	
	Missing device and in use	Device could not be found during the last device search
	Missing device and not used	A virtual, or a real device that was no longer found during the last device search.
	Real device and not used	
	Real device in use and in order	
<b>Especially for DT8 multi-channel drivers (TW, RGB, RGBW)</b>		
	Deactivated and part of a device combination	Cannot be used as a single driver
	Part of a device combination and in order	Cannot be used as a single driver

### 3.2.2 Coupler

By default, couplers are displayed as individual inputs in the directory tree, sorted by input type.

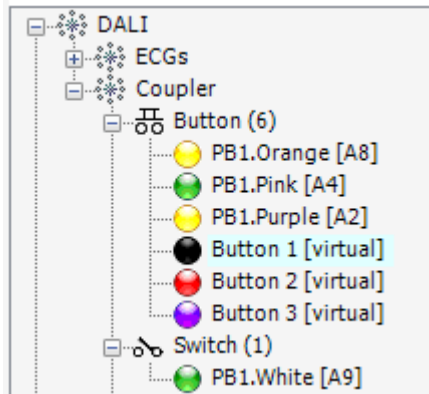

The color here also shows the status:

Color	Status	Remark
	Deactivated	
	Error and in use, or virtual and in use	Device could not be found during the last device search
	Virtual device and not used	Locally created device
	Real device and not used	
	Real device in use and in order	

Alternatively, the view in the project options (1) can be changed to "Show couplers" or "Show individual inputs and couplers". In the latter case, each input is listed twice in the view (2).

Options **1**

- 1. Features**
  - LAN Interconnect Yes
  - KNX functionality Yes
  - Step sequencer Yes
  - Zone separator Yes
  - Swarm function Yes
  - Other controller supported Yes
  - Predefined Configuration Yes
  - Fast mapping Yes
- 2. Visibility**
  - Coupler in the tree only Input **2**
  - Area in the tree Yes
- 3. Extended**
  - Update level Yes
  - Query lamp failure Yes

Inputs are displayed twice and sorted by type and device.

### 3.3 Connection of functions in the graphical view

In the graphical view, inputs and outputs can be connected via functions.

This is done by dragging an input device (e.g. a push-button) and an output device (e.g. a driver) from the device tree onto the surface. A new group is automatically created for the driver. To connect devices, drag a connection from one box to another by starting with one box and holding down the mouse button:

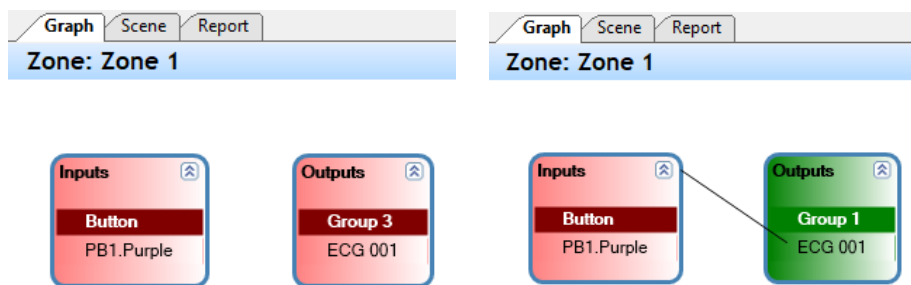

If a connection is possible, a suitable function is automatically created between the devices.

An alternative way to establish a connection is to first drag the output device onto the surface and then drop the selected input device onto this output device in the second step.

An action mapping box is then automatically created in which all stored devices are saved.

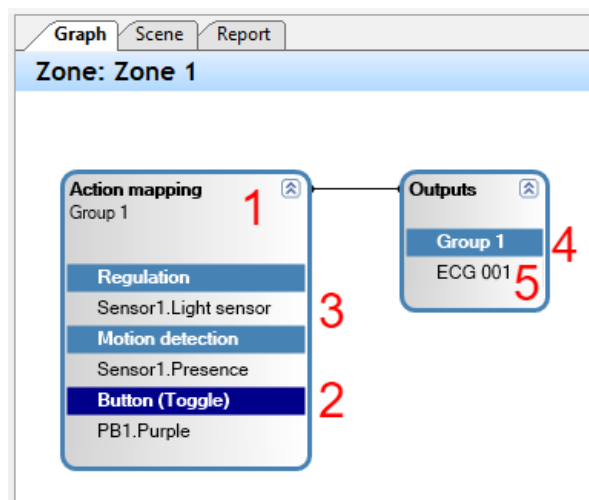

#### Action Mapping (1)

Overview of all functions in the function collection. The parameters of each function are displayed in their own category.

#### Function (2)

Only the parameters of the selected function are displayed.

#### Input (3)

The properties of the selected input (e.g. a DALI sensor or a timer) are displayed.

#### Group (4)

The parameters and the collective properties, e.g. of a lighting group, are displayed.

## Output device (5)

The properties, e.g. of an individual driver, are displayed.

The settings of the various devices and function parameters can be displayed and, where possible, edited according to the selection in the graphic display.

If more than one function is possible for the connection, you can switch between the different options in the properties of the function.

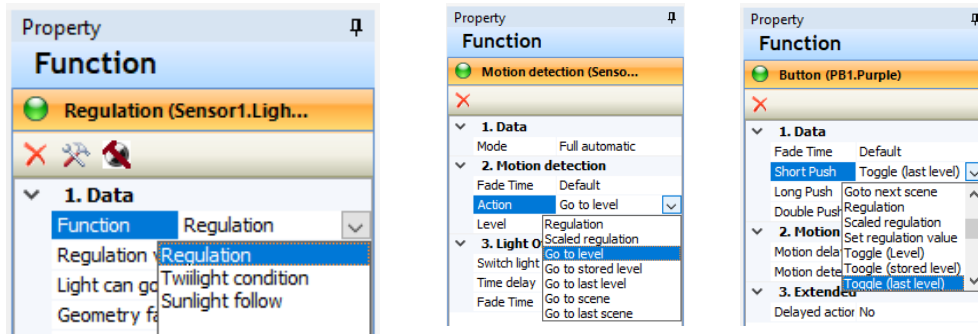

## 3.4 Create a new configuration/ project

The following steps are required to create a new project:

- Establish a connection to the controller
- Search for DALI devices
- Combine DALI devices to functions
- Upload configuration

### 3.4.1 Establishing a connection to the controller

A connection can only be established to the controller type (DALI PRO CON4 RTC, DALI PRO 2 IoT) that is compatible with the controller type, set in the active project. The controller type must be selected when a new project is created via the icon (1)

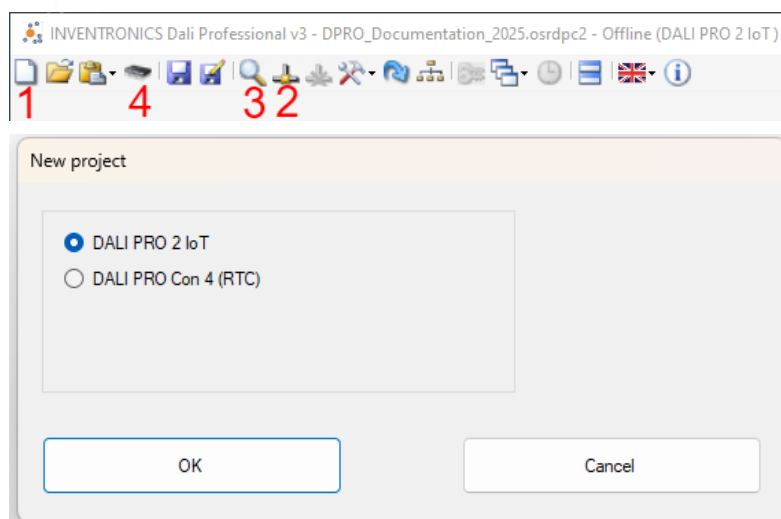

The connection is established via the connection icon (2) or the device search icon (3) or via the project download icon (4).

The rest depends on the controller type and the type of connection.

### 3.4.1.1 Connection to the DALI PRO 2 IoT via WLAN

Once the Laptop is connected to the internal DALI PRO 2 WLAN, you can search for the device, which will always appear with the following IP address **192.168.8.1**

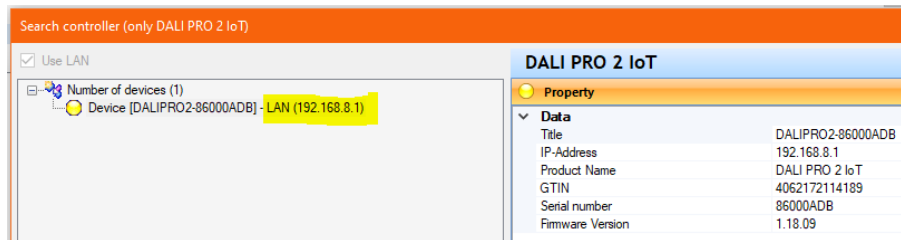

After clicking OK, you will be prompted to enter your username and password.

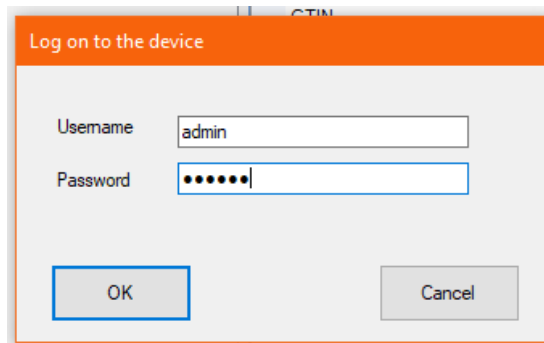

If the controller is being used for the first time or has been reset to the factory settings, initial registration is required and is described in the following section

### 3.4.1.2 Connection to the DALI PRO 2 IoT via the LAN socket

You can connect DALI PRO to a router via a LAN cable. By default, the IP address is assigned via DHCP and the LAN network used should provide this feature. Alternatively, it is possible to set a fixed IP address using the WLAN dongle and the local WLAN.

A search is made for all available controllers that are displayed in the connection dialog.

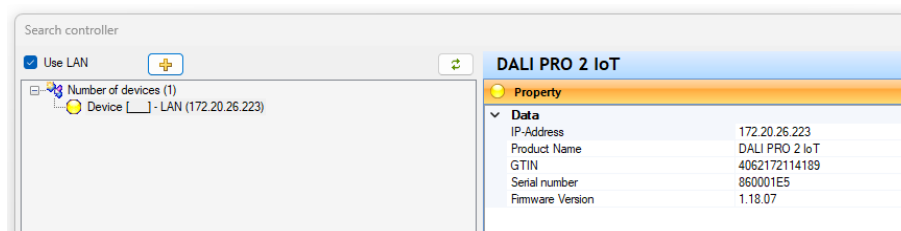

Depending on the firewall and network settings, this automatic search using UDP and multicast may be blocked. It is also possible to enter the IP address of a controller directly using the + button.

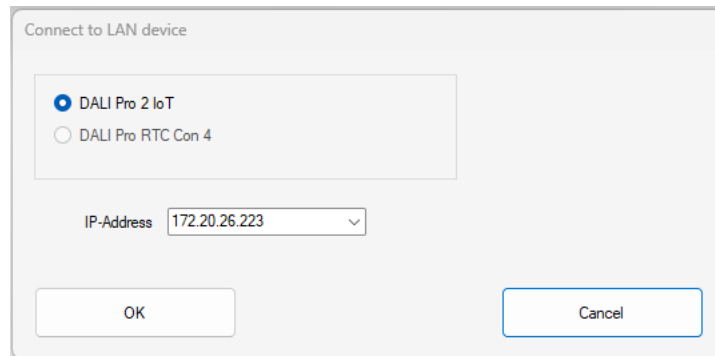

**Note:** Due to the encrypted connection between the PC-Tool and the controller, it is important that the time on the controller is set correctly. The PC-Tool attempts to detect and automatically correct this error when establishing a connection. If this is not successful, the time can be corrected manually via the Web UI on the device.

### 3.4.1.3 First-time login to the DALI PRO 2 IoT

The easiest way to create the access data is to use the internal WiFi. As described above, connect the laptop to the WiFi of the DALI Professional Controller.

Open the PC tool and click the connection icon.

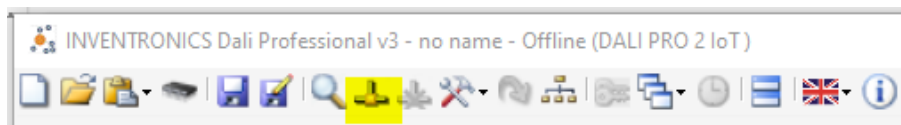

After that you can choose the controller with the IP address 192.168.8.1 and click OK

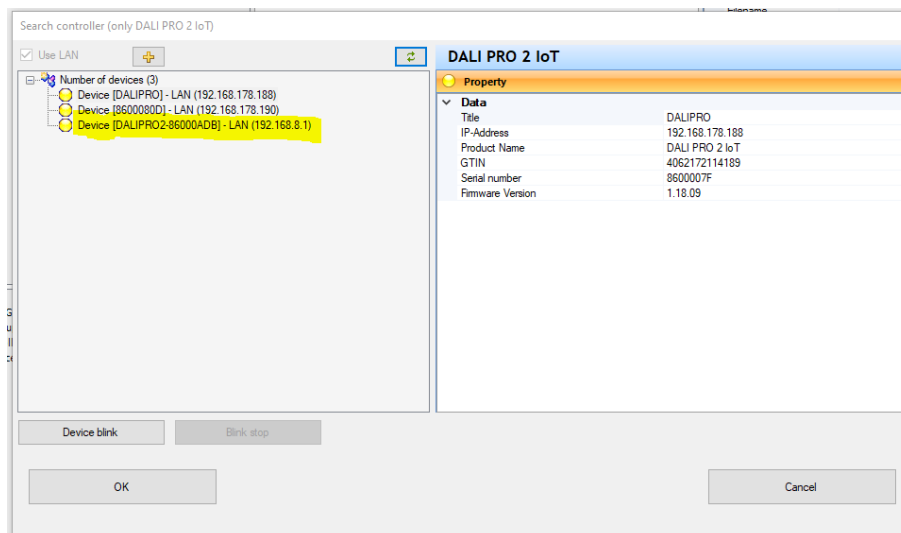

If no login data has been saved, the **First Log-In** window will open automatically.

#### Step 1: Assign a Controller Name

You can assign a custom name to the controller. By default, the serial number is displayed, but using a meaningful name—such as the customer name and location (e.g., **INV\_First\_Floor**)—is recommended.

## Step 2: Set Up User Accounts

- Assign a **username** for the **administrator**.
- Assign a **username** for the **mobile app user**.
- Create a **password** (minimum 6 characters).
  - Allowed: uppercase and lowercase letters, numbers, and certain special characters.
  - If the passwords in the "Confirm" field do not match, an error message will appear.

The screenshot shows a 'First Log-In' dialog box with the following fields and options:

- Device settings:**
  - Device name: DALIPRO2-86000ADB
  - Time Zone: [dropdown]
  - Location: Germany (Berlin)
- Administrator:**
  - User name: [text box]
  - Password: [text box]
  - Repeated Password: [text box]
- Mobile App:**
  - User name: [text box]
  - Password: [text box]
  - Repeated Password: [text box]

At the bottom, there is a checkbox labeled 'I accept and agree to Terms of Use and OSRAM Privacy Policy' and two buttons: 'OK' and 'Cancel'.

**Important:** Store the administrator password in a safe place.

- The password **cannot be retrieved later**.
- Access to the controller settings is only possible with the administrator password.
- If the password is lost, the **controller must be reset to factory settings**, and **all configurations will be lost**.
- The project file can be re-uploaded, but it **cannot be downloaded without the password**.

## Step 3: Set Time Zone & Location

- Enter the **installation location** of the controller.
- The **local position** is essential for:
  - Sun position-based scenarios.
  - Correct time synchronization.
- Verify the **current local time** (it can be adjusted later).
- For a smooth commissioning process, ensure that the controller's time is synchronized with the system time of the laptop.

**Step 4: Accept Terms & Continue**

- Accept the **Terms of Use** and **Privacy Policy**.
- Click **OK** to proceed.

If everything is OK, you are then logged in and connected to the controller.

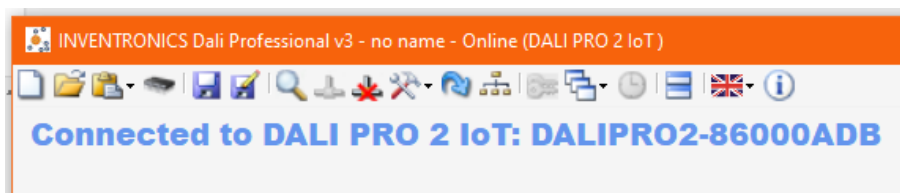

Alternatively, you can perform the initial registration using the integrated WEB UI. For more details on this method, refer to our WEB UI Quick Start Guide, available here: [Dali Pro 2 IoT – InvenTronics](#).

**3.5 New Project / Project Features**

You can create a new project by clicking on the blank page icon (1)

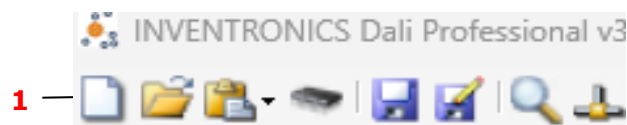

A pop-up window will appear, allowing you to enable various project-specific functionalities. These are described in detail in the following chapters.

You can access and enable these features at any time, by right clicking on the Controller, in the device tree:



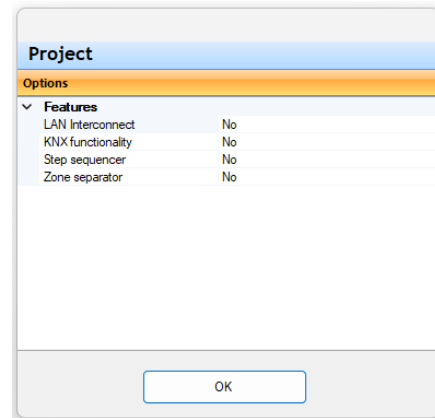
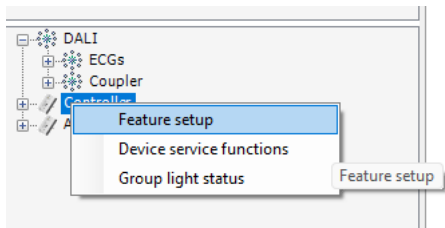

### 3.5.1 Search for DALI devices

Before starting the scan, the system will automatically check the firmware version.

A minimum firmware version is required for the **DALI PRO CON 4 RTC**. If the installed version does not meet this requirement, a firmware update is necessary. The firmware is already included in the DALI PRO software, so no additional firmware file is needed. If "Firmware update is required" appears, please follow the provided instructions to complete the update.

All software versions are compatible with the **DALI PRO 2 IoT**. However, depending on the installed version, some features may not be supported or available.

If a firmware update is required, follow the steps outlined in the Firmware Update instructions, in chapter 15.

#### Device Scan

If the search is started via the device search icon in the quick access toolbar, all connected DALI ECGs and couplers/sensors are searched for on all ports (A, B, C, and D for DALI PRO CONT-4, A and B for DALI PRO 2 IoT).

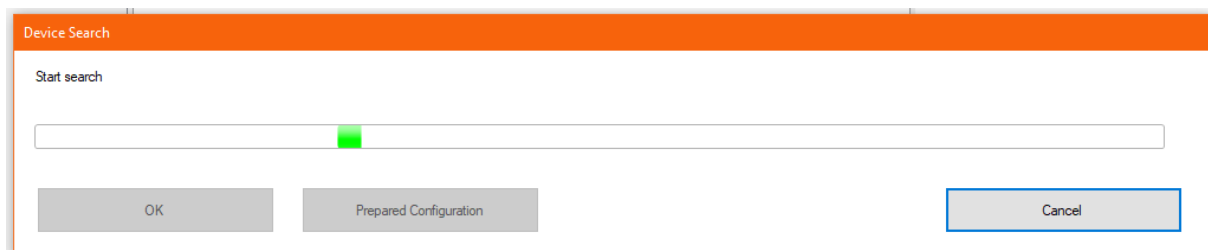

However, if the search is started via the icon in the device tree or via the context menu after selecting the DALI ECG or coupler, the search is restricted to the respective device family. You can also select the DALI lines/DALI ports (A to D) on which the search is to be carried out.

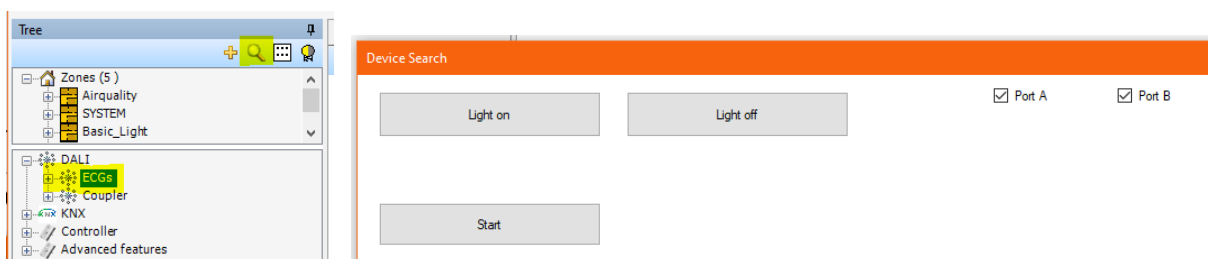

During the scan, the system will temporarily pause its operations and resume once the scan is complete.

While the system is in this paused state, the DALI PRO controller's "Plug and Play" LED will blink rapidly in red.

The protocol to be used for the sensor search is selected in the general project settings (1).

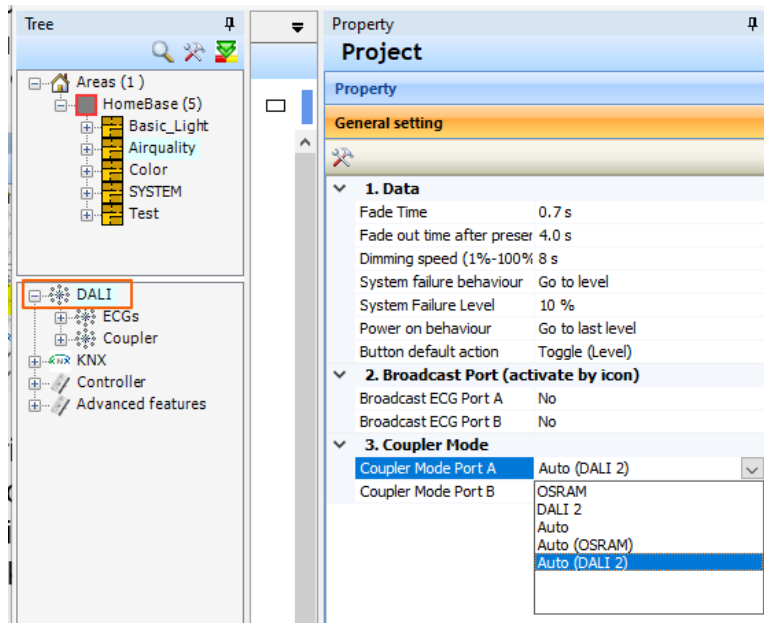

Coupler mode	Description
<b>OSRAM</b>	<b>Only the proprietary OSRAM protocol is used. Switchable sensors are set to OSRAM mode beforehand.</b>
<b>DALI 2</b>	<b>Only the DALI 2 (Part 103) protocol is used. Switchable sensors are set to DALI 2 mode beforehand.</b>
<b>Auto</b>	<b>The proprietary OSRAM protocol and the DALI 2 (Part 103) protocol are used. Care is automatically taken to ensure that each short address is only used once, regardless of the protocol used.</b>
<b>Auto (OSRAM)</b>	<b>Same as Auto, but all switchable devices are set to OSRAM mode beforehand. (Not supported by all DALI PRO 2 IoT firmware versions).</b>
<b>Auto (DALI 2)</b>	<b>Like Auto, additionally all switchable devices are previously set to DALI 2 mode. (Not supported by all DALI PRO 2 IoT firmware versions).</b>

The DALI PRO CON 4 RTC is designed for use with OSRAM/ Inventronics sensors, either through the proprietary OSRAM protocol or DALI 2 protocol. While operation with third-party DALI 2 sensors is not excluded, it cannot be guaranteed.

DALI PRO 2 IoT is a DALI-2 certified controller and supports all DALI-2 input devices.

### Test Function and System Restart

During the device search, the system is stopped and only automatically restarted when the search is complete. After using test functions, the system is also stopped and must be restarted manually.



In the "System stopped" status, the DALI PRO Controller flashes quickly with the red "Plug and Play" LED (also flashes during the firmware update since version 3.21).

If the DALI PRO Controller no longer responds, check whether the controller is in "Stop" status. This status can also be terminated with a mains voltage interruption.

#### 3.5.1.1 Scan results

During addressing, devices without a short address are only readdressed if duplicate addressing needs to be resolved.

Error Report

**Error and warnings**

Typ	Device	Title	Port	Short address	Comment
Warning	DALI 2 Input	ControlDevice: A7	A	7	Multi addressing
Info	DALI 2 Input	ControlDevice: A7	A	7	Remove multi short address

After the search, an overview of the devices found is displayed with the number of devices of the respective type found (2).

Device Search

Search finished

**Overview**

Device class	Amount
Ballast	4
Coupler	3
Inputs	8

Number of found ECGs.

Number of found coupler devices

Number of all single inputs over all coupler devices.

**Ballast**

Amount	DALI Version	GTIN	Firmware Version	Product name	Comment
4				OTI DALI 75/220...	

Go on with localisation.

Close dialog (the localisation can be done at any time).

**Coupler**

Amount	GTIN	Firmware Version	Product name

Go on

Close

The button (3) “Go On” can be used to start the interactive device localization directly, while the button (4) is used to close the dialog. Device localization can also be carried out later.

### 3.5.1.2 ECGs Localization

A separate dialog is available for the ECG localization. Depending on the filter settings, a list of devices to be localized will be shown. From these devices the currently selected one is blinking.

For the selected device you can:

- Change the name.
- Change the short address used (5).
- Add to a group (or part of Tunable White / RGB device). The group can also be generated from the dialog.
- Merge with virtual and already used devices. This feature is only visible if any virtual and used devices exists.

After this handling the localized devices will be removed from the list (depending on the actual filter settings).

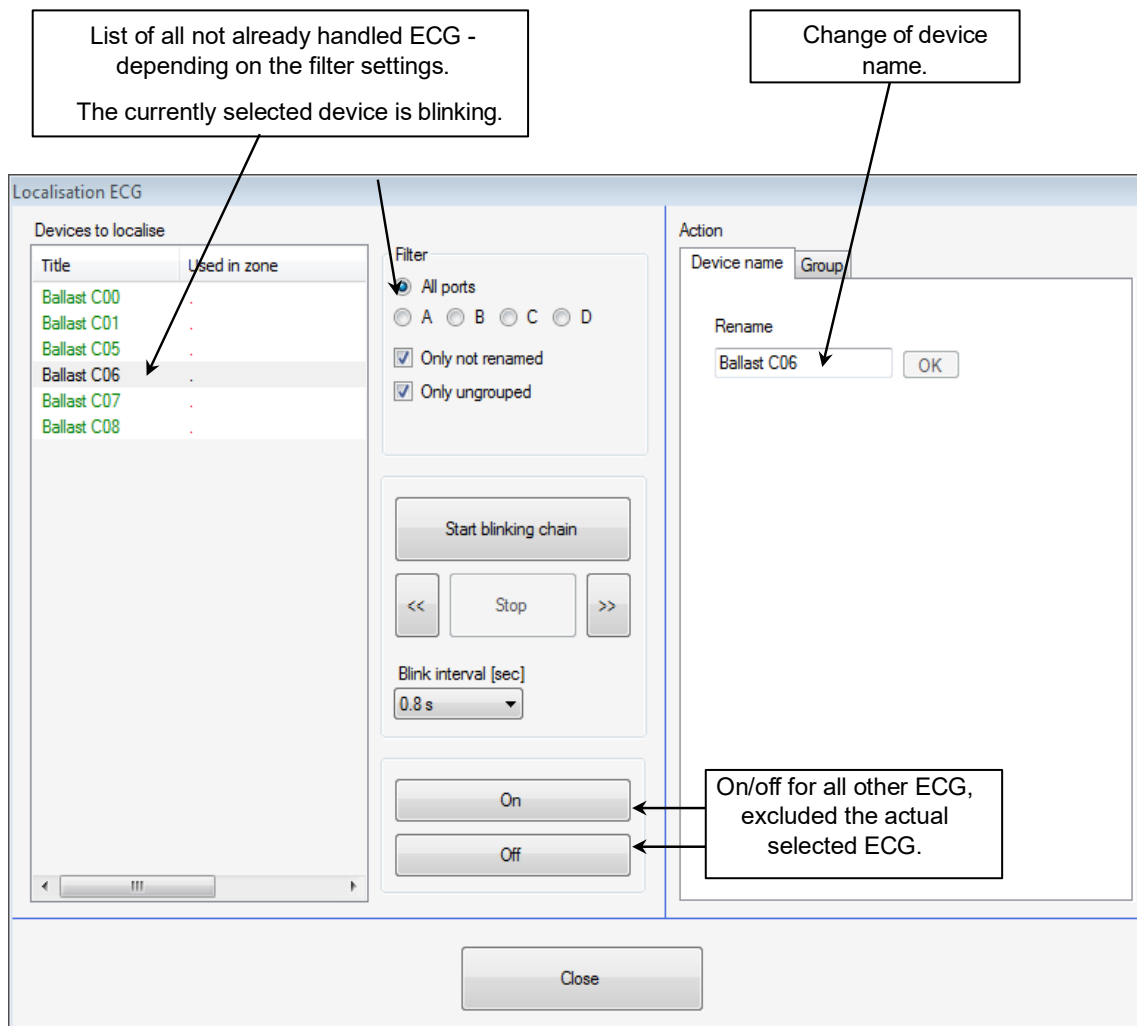

If both virtual and used ECGs exist, they can be merged. Depending on the filter settings, the ECG may be hidden after the merge.

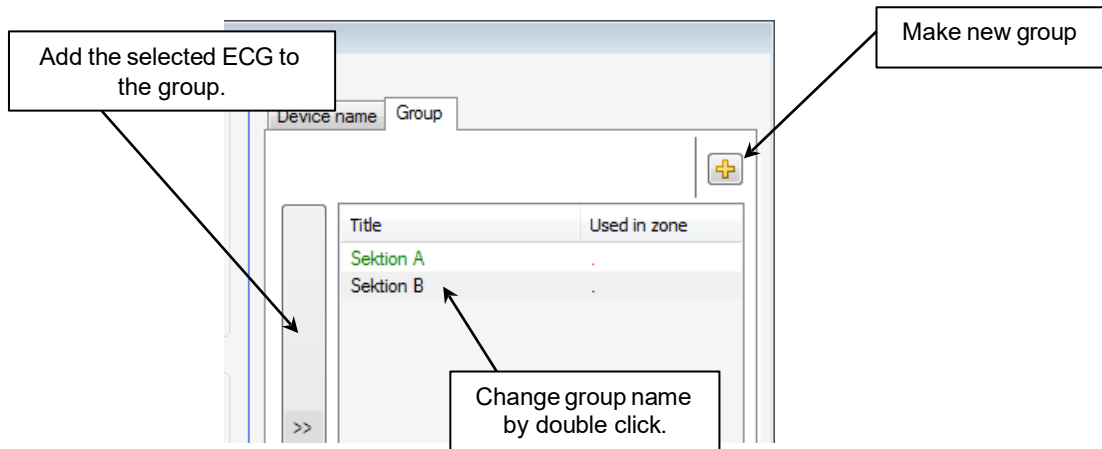

The Plus button can be used to create new groups. These groups will appear in the device display and can be dragged from there into the Graph Panel for further use (8).

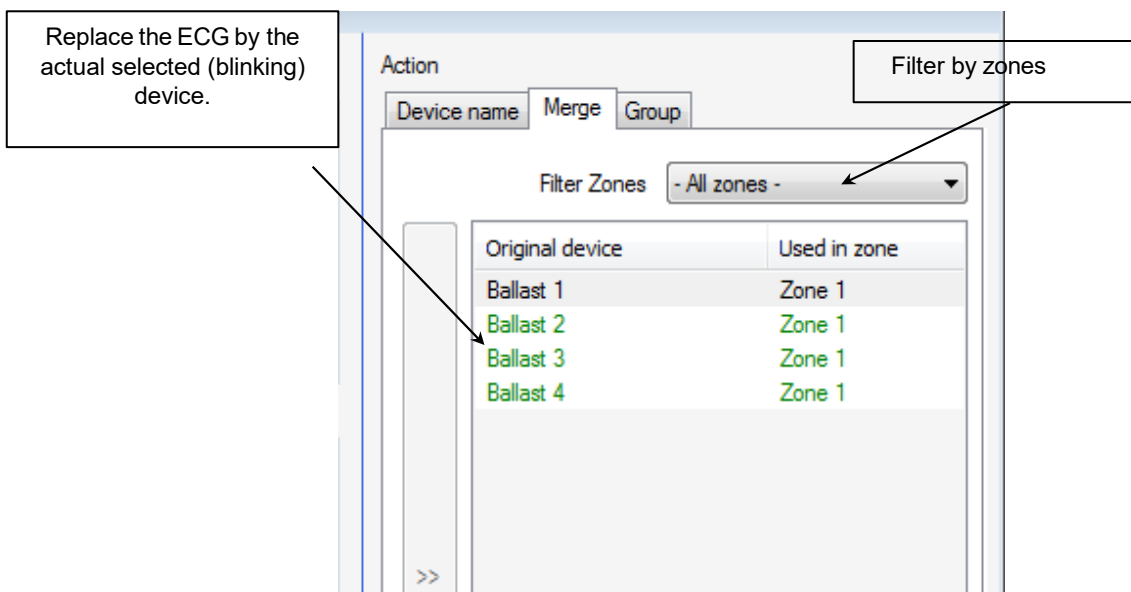
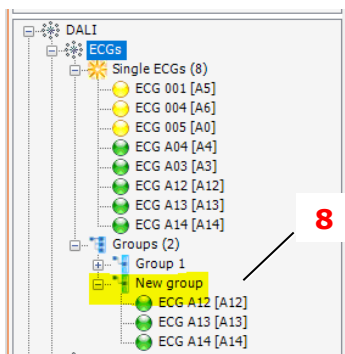

The localization function is always available via the tree context menu or icon when the ECG topic is selected in the tree.

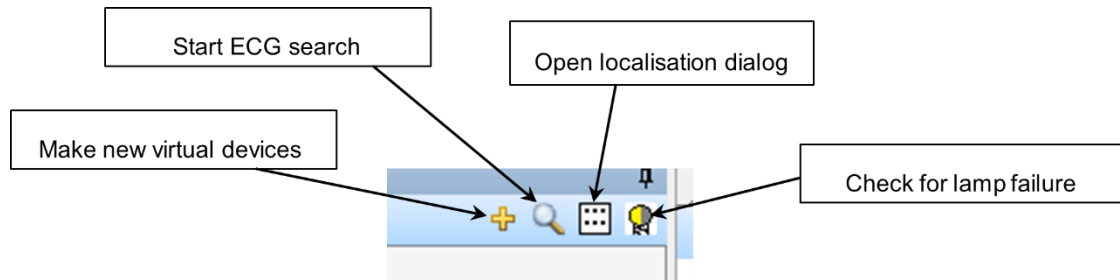

### 3.5.1.3 Coupler Localization

If not initiated immediately after the device search, localization and other important coupler functions can be started via the context menu or the icons in the device view

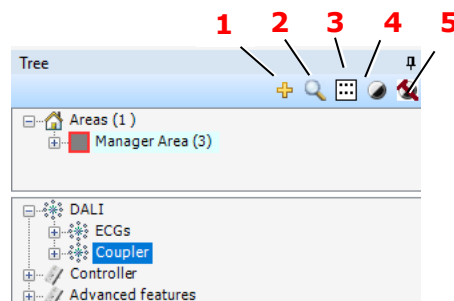

The device search for DALI couplers includes the option to search on selected DALI ports only (1), the coupler localization function (2), the light sensor monitor function (3), the settings dialog for the controls (4), and a function to set all virtual couplers (devices to which no real DALI couplers could be assigned) to inactive (5).

Localization is possible for individual coupler inputs as well as for the entire coupler (6), such as after replacing a coupler.

The localization process for real devices depends on the type of coupler:

- **For push-button couplers**, press the button.
- **For sensors**, either detect motion or activate the LED by selecting the device in the list.

To select a device in the list based on a button press or motion detection, click the **"Select by event"** button (10). A green field will appear to the right of the button, indicating the system is ready when no device is currently selected. Once a real button is pressed, the corresponding device in the list is automatically selected (provided it is included), and the green field disappears. After renaming the device, the process restarts, and the green field reappears to indicate readiness again.

When naming inputs, remember that the name is made up of two parts (11):

- **[Coupler name].[Input name]**

The **coupler name** represents the entire push-button coupler or sensor, while the **input name** refers to individual push-button inputs or specific components, such as motion or light sensors. This naming convention helps easily identify which components are part of a particular device.

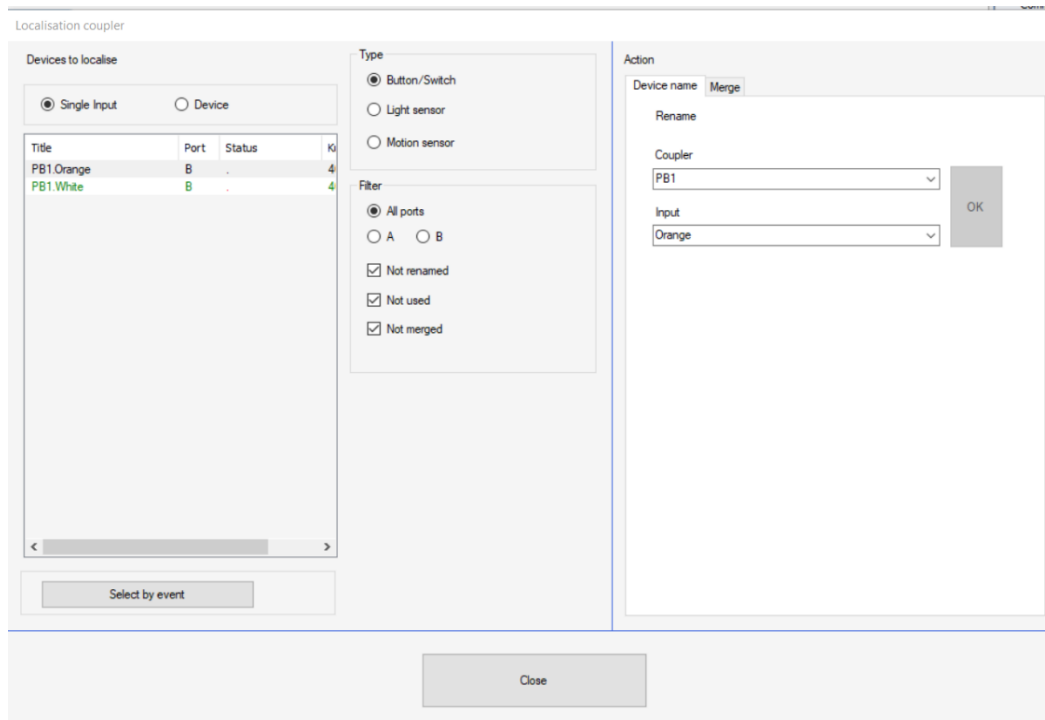

For light sensors and motion detectors, the LED on the device lights up when selected in the list. Like ECGs, these devices also support a **flashing chain feature** (12). The typical sequence is as follows: the LEDs on all devices in the list flash briefly one after another (the flashing interval can be adjusted). During this process, the device being localized is observed, and once its LED lights up, the flashing chain is stopped, and the device is automatically selected in the list.

In the **Coupler View**, only the entire coupler can be localized or renamed (for example, for buttons, this applies regardless of which button was pressed).

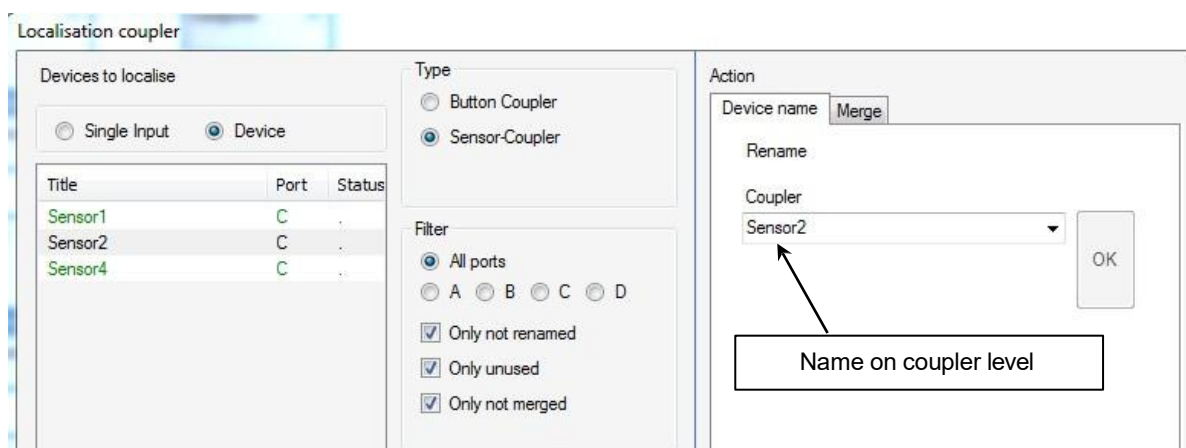

### 3.5.1.4 Coupler Merge

Virtual and used couplers can be replaced by unused and real couplers. This can be done at either the **single input** level or the **coupler** level.

### Single Input Level

At this level, individual inputs within a coupler can be merged.

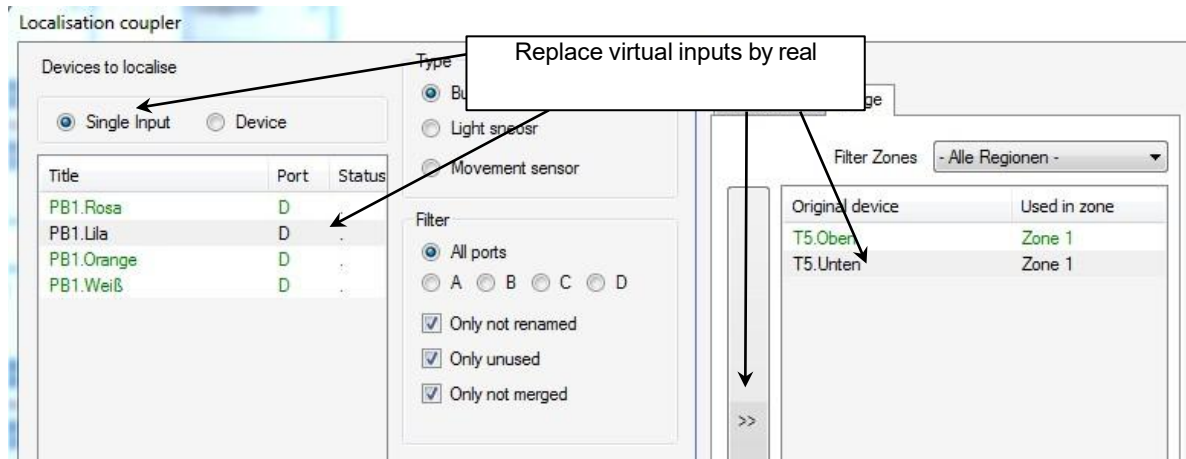

### Coupler Level

- Merging at the coupler level is only possible if none of the individual inputs of the coupler have already been merged.
- The real coupler will completely replace the virtual coupler, and the unnecessary virtual coupler will be deleted.

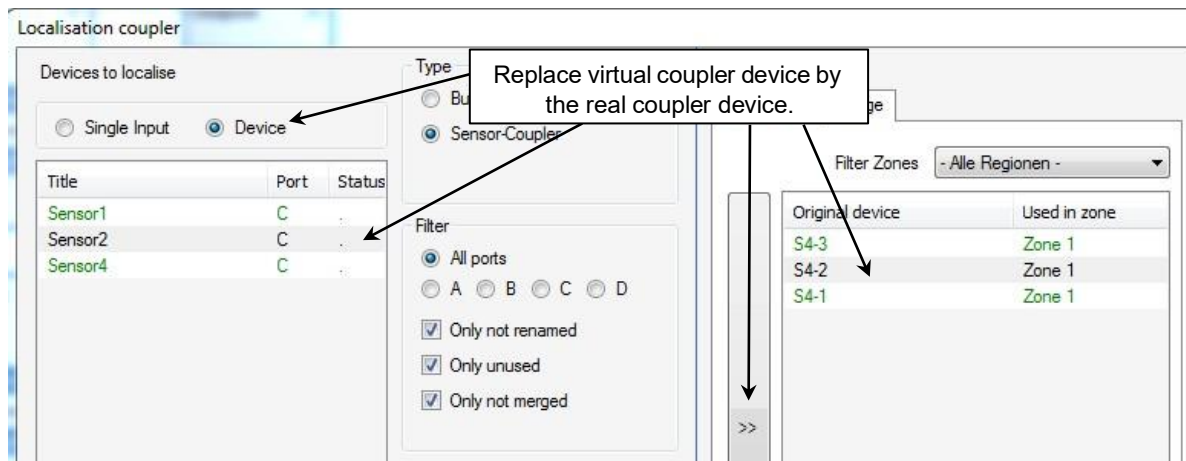

### 3.5.2 Linking DALI devices via functions

To create functions, an input, for example a button (1) and an output, for example an ECG (2), must be dragged and dropped into the graphical view.



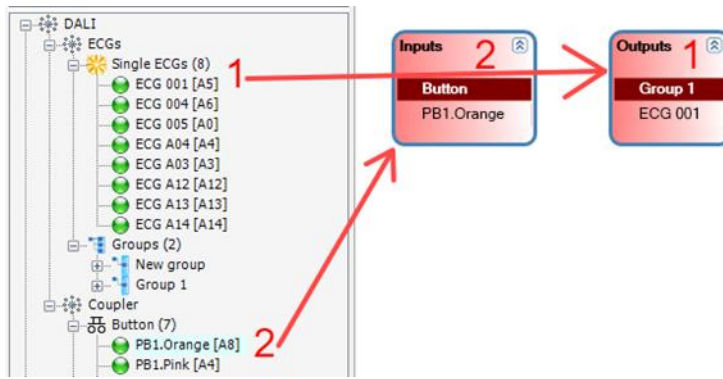

For ECGs, it is also possible to make multiple selections in the device view using the Ctrl or Shift key.

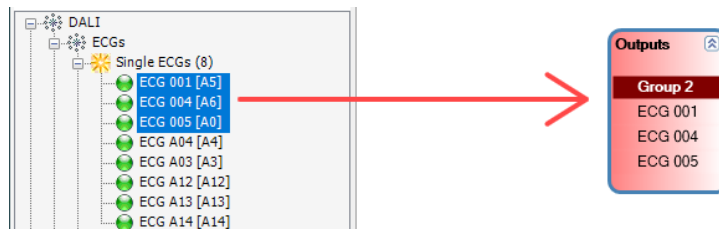

These two boxes can then be connected using the mouse (click on one box and connect the line that appears with the second box).

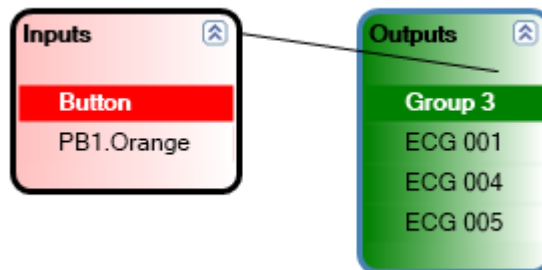

Alternatively, you can first drag an output onto the graphical view and then, in the second step, drop the input directly onto the output. This action automatically links the two devices together.

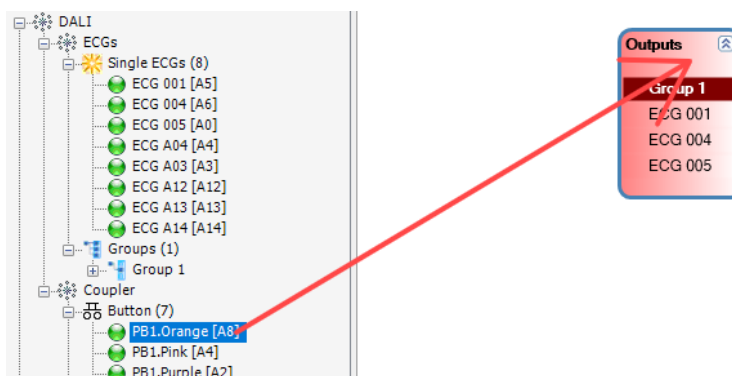

The connection fixes the devices in the current zone. If no zone exists, a new zone is automatically created.

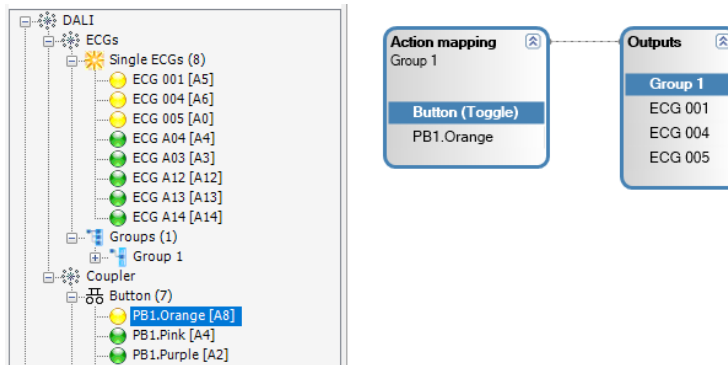

Until the devices are connected (indicated by them being displayed in red), they do not belong to any specific zone and remain visible until they are used, regardless of any changes to the currently selected zone. Therefore, it is practical to only add devices that will be integrated next.

In the group properties, you can change the group title (3) or adjust the parameters of all ECGs in the group (4).

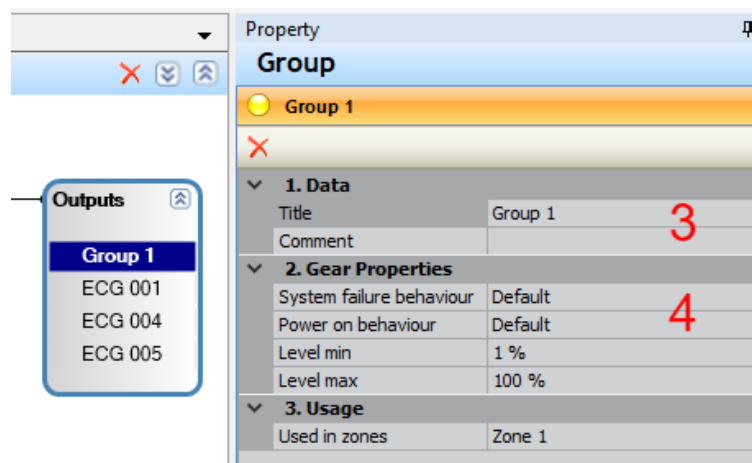

All created groups are also displayed in the device view. All groups that are not used can simply be deleted via the context menu. (5)

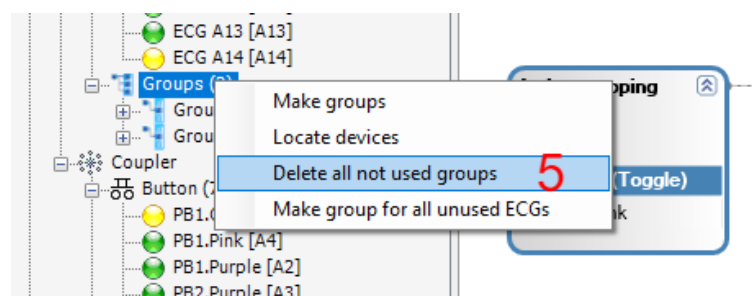

You can change the function parameters of the link by selecting a function in the graphical view.

(6)

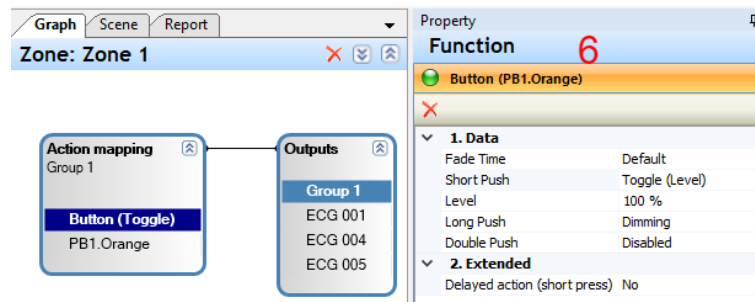

Selecting an ECG or input in the device view or in the graphical view (7) displays the individual device properties. Here it is also possible to change the device name (8), for example.

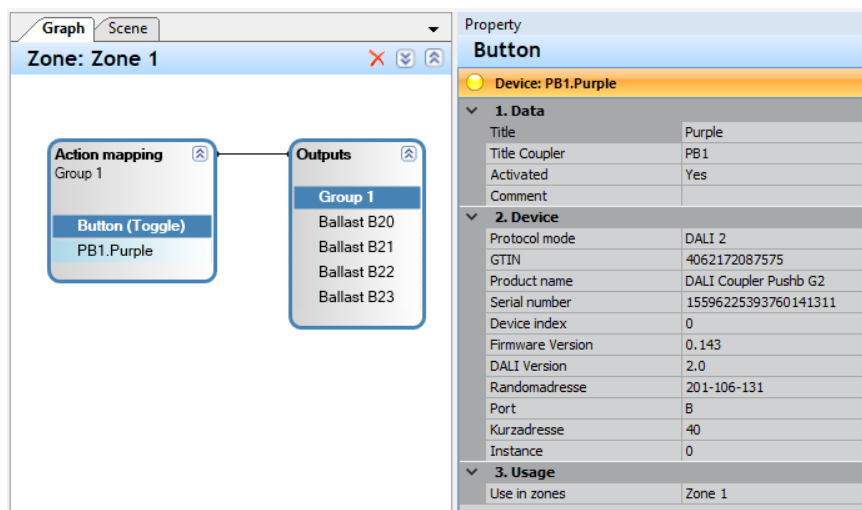

### 3.5.3 Upload configuration

Before uploading, the configuration must be saved. Clicking on the icon (1) opens the upload dialog box.



First, the configuration undergoes error checking. If no errors are found, the upload process can commence.

Each time a new configuration is uploaded, a copy of the project file is created with a timestamp extension: [ProjectFileName][Date+Time].osrdpc2u

The file is saved in the directory: C:\Users[user name]\Own documents\Inventronics\DALI Professional 3\Upload

Project files with the extension ".osrdpc2u" can be opened but not overwritten. To edit such files, use the "Save as" icon to create a copy with the normal ".osrdpc2" extension.

➔ You can also use the check configuration option included in the tool menu. This can also be used if the controller is not connected.

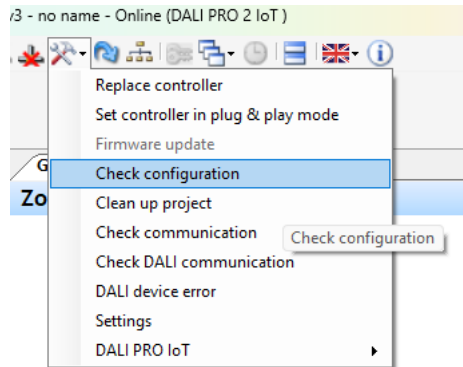

## 4 Basic functions

### 4.1 ECG Groups

Buttons and sensors are typically connected to the ECGs via groups. A group is automatically generated when an ECG is moved from the tree to the graph panel.

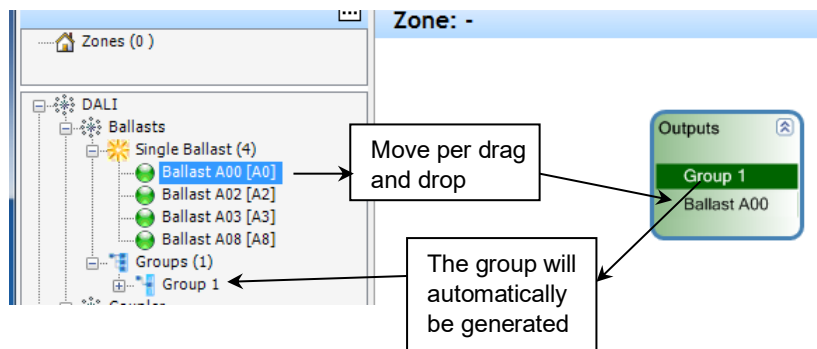

Multi-selection of ECGs is supported by holding down the Shift or Ctrl keys (Shift for range selection, Ctrl to add individual items).

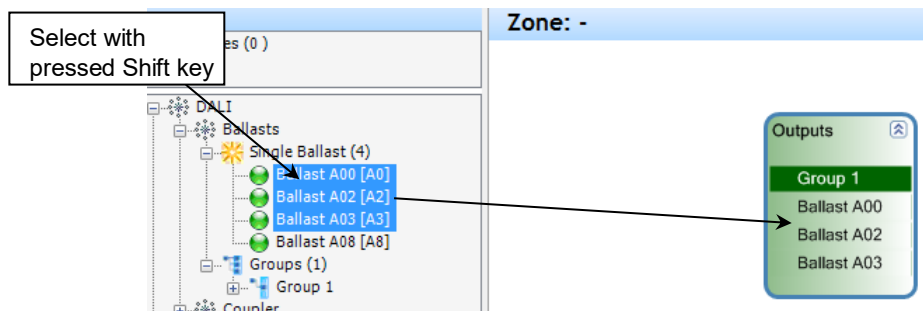

Group properties allow customization. You can change the group title or modify parameters for all ECGs within the group.

Property  
**Group**

Room 101 Left

1. Data  
Title Room 101 Left  
Comment

2. Gear Properties  
System failure behaviour Default  
Power on behaviour Default  
Level min 1 %  
Level max 100 %

3. Usage  
Used in zones 1st Floor

Outputs  
Room 101 Left  
ECG 001  
ECG 004  
ECG 005

Title of the group is changeable (1)

Properties of all ECGs in the group (2)

Info on the zone in which the group is used (3)

Once a group is created, it can be reused across different zones, providing flexibility. For example, group 1 should be displayed on the 1st floor and on the 2nd floor.

Tree

Areas (1)  
Area 1 (2)  
1st Floor  
2nd Floor

DALI  
ECGs  
Single ECGs (8)  
ECG 001 [A5]  
ECG 004 [A6]  
ECG 005 [A0]  
ECG A04 [A4]  
ECG A03 [A3]  
ECG A12 [A12]  
ECG A13 [A13]  
ECG A14 [A14]

Groups (1)  
Group 1

Zone: 2nd Floor

Outputs  
Group 1  
ECG 001  
ECG 004  
ECG 005

Move per drag'n drop

If you now add another button to the action mapping, you will see both devices. One from zone 1 is in brackets, the other without, the view from zone 2 shows the opposite.

1st Floor  
2nd Floor  
Group 1

ECGs  
Single ECGs (8)  
ECG 001 [A5]  
ECG 004 [A6]  
ECG 005 [A0]  
ECG A04 [A4]  
ECG A03 [A3]  
ECG A12 [A12]  
ECG A13 [A13]  
ECG A14 [A14]

Groups (1)  
Group 1

Coupler  
Button (7)  
PB1.Orange [A8]  
PB1.Pink [A4]

Action mapping  
Group 1  
Button (Toggle)  
PB1.Orange  
Button (Toggle)  
PB1.Pink

Outputs  
Group 1  
ECG 001  
ECG 004  
ECG 005

Please note that the group is physically only used once. All inputs and functions are always displayed for the entire group.

For easy cleanup, unused groups can be deleted using the context menu.

Ballast A08 [A8]

Groups (2)

Group  
Group

Coupler  
Button (3)  
PB1.Orange [A8]  
PB1.Pink [A4]

Make groups  
Locate devices  
Delete all not used groups  
Make group for all unused ballasts

## 4.2 Creation of button functions

All OSRAM and Inventronics push-button couplers are fully compatible for use. Additionally, any DALI-2 compliant push-button coupler can be integrated with the DALI PRO 2 IoT controller.

These push-button couplers can be configured to perform various control functions, such as triggering lighting scenes, adjusting brightness, or controlling specific zones. The system allows for easy customization of button actions.

### 4.2.1 Direct actions

The push-button functions, such as short, long and double press, can be set individually. The fade time is valid for all actions that have to do with changing the brightness. The default values are set with the "Default" value. The fade times are set according to the DALI standard.

Clicking on the Button element inside the Action Mapping window will display the following options in the Properties window:

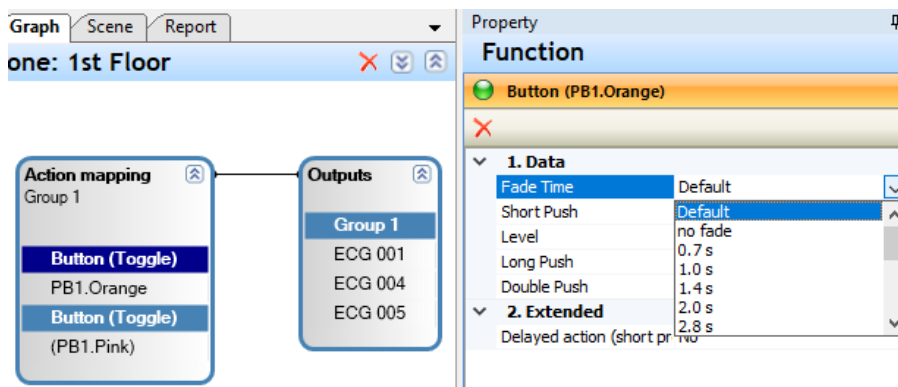

Option	Description	Parameters/Examples
<b>Fade Time</b>	Duration to dim to the new brightness level.	Default (uses the time from the general settings) No fade 0.7 – 90.5 s
<b>Short push</b>	Select action for a short push of a button.	See 3.2.1.1 <i>Short Push actions</i>
<b>Long push</b>	Select action for a long push of a button.	See 3.2.1.2 <i>Long Push actions</i>
<b>Double push</b>	Select action for a double push of a button.	See 3.2.1.3 <i>Double Push actions</i>
<b>Delayed action</b>	Define up to two delayed actions for a short push. If one or two actions will be configured, the additional properties for each action will be displayed	No 1 2

**4.2.1.1 Short Push actions**

The following functionalities are available for short push button actions. Please note that certain options will only be displayed if a compatible device type is present (e.g., RGB/W or Tunable White).

<b>Short push action</b>	<b>Description</b>	<b>Parameters/Examples</b>
<b>Off</b>	Switches off the light.	
<b>Go to level</b>	Turns the light on and dims the brightness to the specified parameter value.	Level (0 – 100 %)
<b>Go to last level</b>	Turns the light on and restores the brightness to the level it was set to before the light was switched off.	
<b>Go to scene</b>	Turns the light on to the scene selected by name..	Scene, see 3.4 <i>Add and configure a colored scene page 18.</i>
<b>Go to next scene</b>	Turns the light on to the scene selected by name.If Scene 1 is already active, pressing the button will recall Scene 2, looping between scenes with each button press	Scenes count (numbers, up to five scenes possible) Scene 1 Scene 2 Scene 3 ...
<b>Toggle (level)</b>	Toggles between off and the light value specified in the additional parameter level.	Level (0 – 100 %)
<b>Toggle (stored level)</b>	Toggles between off and the light level stored at the driver.	
<b>Toggle (last level)</b>	Toggles between off and the brightness level used during the last time the light was on.	
<b>Toggle (scene)</b>	Toggles between off and the scene selected by name.	Scene, see 3.4 <i>Add and configure a colored scene page 18.</i>
<b>Toggle (level/ color temperature)</b>	Toggles between off and the defined brightness level and color temperature.	
<b>Go to Color Temperature</b>	Turns the light on to the selected color.	Color (RGB/W settings), see 3.3.7 <i>Setting a color value, page 17.</i>
<b>Go to Color Temperature and Level</b>	Turns the light on to the selected color and brightness level.	Level (0 – 100 %) Color (RGB/W settings), see 3.3.7 <i>Setting a color value, page 17.</i>
<b>Color Double light</b>	Only for special use cases with Tunable White	Level (0 – 100%) Simultaneously for both color channels.
<b>Lowering</b>	Goes to defined % reduction, in relation to the current brightness level, especially during regulation.	5- 99%

<b>Select effect Lighting profile</b>	Choose the active profile from custom created lighting profiles	
<b>Set last level</b>	Retrieves the last level saved in the driver and uses it as the current light level.	
<b>Store light level</b>	Writes the defined light level to the driver	0,1 – 100%
<b>Store light level and update</b>	Writes the defined light level to the driver and uses it as current level	
<b>Go to stored level</b>	Goes to the light level stored in the driver.	Level (0 – 100 %)

The following effects are only visible when an effect (such as an RGB(W) profile or a TW lighting profile) is connected to the Action Mapping box:

<b>Function</b>	<b>Description</b>
<b>Start effect</b>	<b>Starts the effect if not already active. If the effect does not control the light value (i.e., "Change light value" is set to "No"), the light will not be switched on automatically. If the effect does control the light, some steps may switch off the light.</b>
<b>Restart effect</b>	<b>Restarts the effect sequence from the first step, regardless of its current status. For a light profile, this has the same result as "Start effect." If the effect is time-based (e.g., determined by the position of the sun), it will play according to the defined schedule.</b>
<b>Stop effect</b>	<b>Stops the effect and keeps the light in its current state without any further changes from the effect.</b>
<b>Toggle effect state</b>	<b>Toggles the effect state: starts it if inactive, stops it if active. Use caution when toggling multiple times.</b>
<b>Next profile</b>	<b>Switches to the next profile in a multi-profile effect without changing its active or paused status.</b>
<b>Select effect lighting profile</b>	<b>Switches to a different lighting profile without affecting the effect's active or inactive status. If the effect is active and the light is on, the change is immediately visible. If the effect is inactive or the light is off, the profile change will take effect the next time the effect or light is activated. (Available from firmware versions: DALI PRO CON 4 RTC from FW 3.83 and DALI PRO 2 IoT from FW 3.1.15.x).</b>



#### 4.2.1.2 Long Push actions

The following functionalities are available for Long push button actions:

Long push action	Description
<b>Dimming</b>	Gradually adjusts the brightness level. With each long push, the direction of dimming (increase or decrease) is reversed. Long push
<b>Dimming Up</b>	Gradually increases the light level (for buttons labeled "Up").
<b>Dimming Down</b>	Gradually decreases the light level (for buttons labeled "Down").

The following effects are only visible when an RGB/W group is connected to the Action Mapping box:

Long push action	Description
<b>RGB circle</b>	Cycles through the colors of the RGB spectrum, displaying over 32 different colors.
<b>RGB circle with white</b>	Cycles through the colors of the RGB spectrum, including white.
<b>Change Red/Green/Blue</b>	Adjust the color values for Red, Green, or Blue.
<b>Increase Red/Green/Blue</b>	Increases the color value for Red, Green or Blue.
<b>Decrease Red/Green/Blue</b>	Decreases the color value for Red, Green or Blue.

#### 4.2.1.3 Double Push actions

The following functionalities are available for Double push button actions:

Double push action	Description	Parameters/Examples
<b>Off</b>	Switches off the light.	
<b>Go to level</b>	Turns the light on and dims the brightness to the specified parameter value.	Level (0 – 100 %)
<b>Go to scene</b>	Turns the light on to the scene selected by name.	Scene, see <i>4.4 Add and configure a colored scene.</i>
<b>Go to Color and Level</b>	Turns the light on and sets it to the selected color and brightness level.	Level (0 – 100 %) Color (RGB/W settings), see <i>4.3.7 Setting a color value.</i>

The following effects are only visible, when an effect (such as an RGB(W) sequence or Daylight Simulation) is connected to the Action Mapping box:

<b>Start Effect</b>	Starts a color effect,	see 4.5 Add and configure a color effect (RGB(W) sequence)
<b>Stop Effect</b>	Stops a color effect,	see 4.5 Add and configure a color effect (RGB(W) sequence)

### 4.2.2 Switches

The push button coupler inputs can be transformed into switch behavior in the tree.

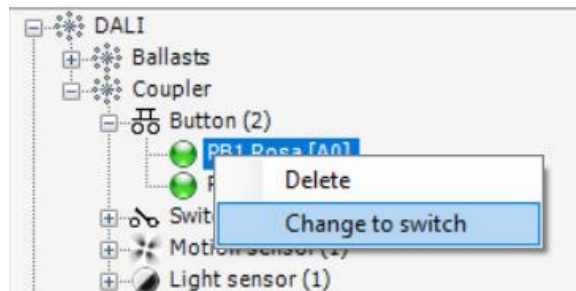

#### Switch Configuration

Right-click on the button, then select “Change to Switch”. The input will now appear under Switches.

#### Switching Modes

Switches can be used in different configurations:

- Parallel Circuit
- Serial Circuit
- Multi-Switch Circuit

They can also be combined in logical configurations.

#### Logical View of Switch Behaviour

Switch A	Switch B	Parallel Circuit	Serial Circuit	Multi-Switch
0	0	0	0	Defined per settings below
0	1	1	0	Defined per settings below
1	0	1	0	Defined per settings below
1	1	1	1	Defined per settings below

#### Switch Behavior:

Standard switching behavior follows logical rules.

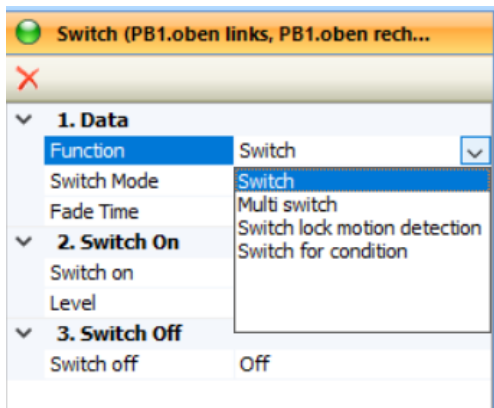

### Multi- Switch Behavior:

Multi-Switch behavior allows custom state definitions for each condition.

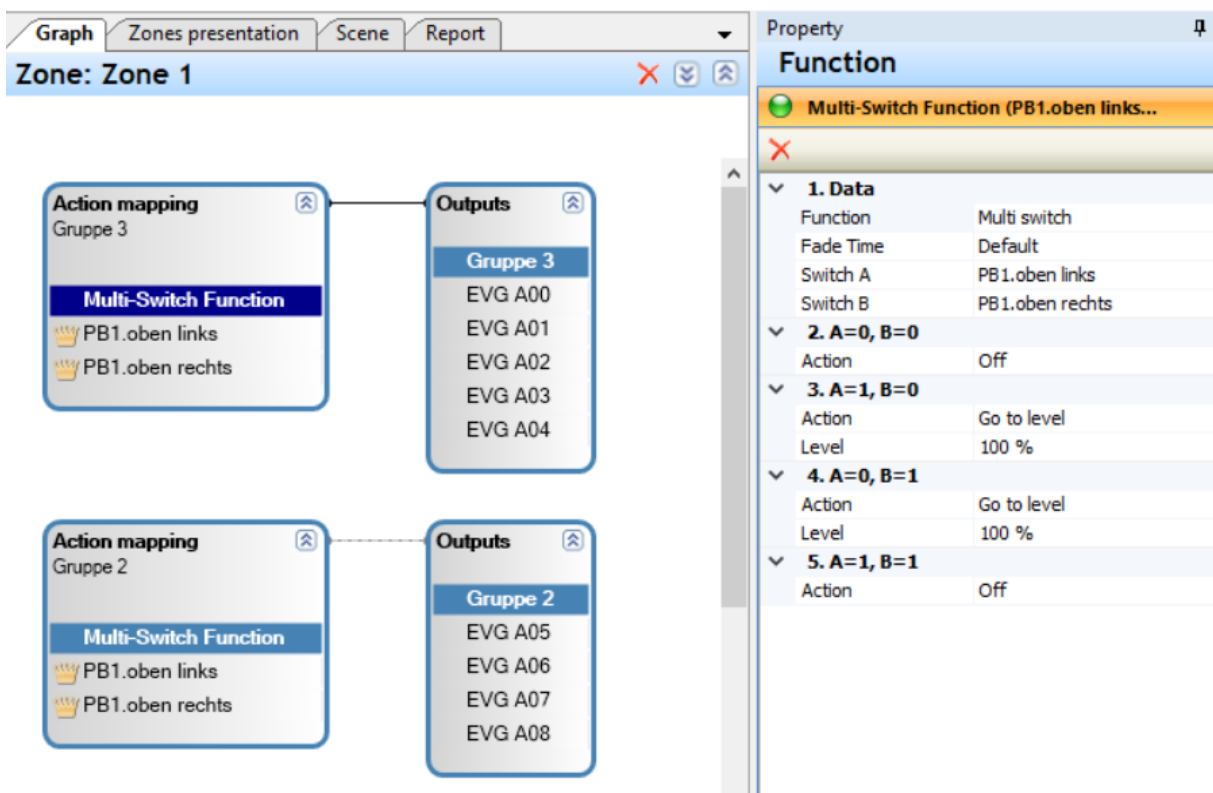

### 4.2.3 Time-delayed actions

In addition to standard direct actions triggered by a button push, the system supports up to two delayed actions, enabling more sophisticated control sequences. These delayed actions allow for time-dependent behaviors, such as staggered lighting adjustments or scene changes.

For even more complex, time-based control scenarios, the sequencer functionality can be utilized. This feature allows for the creation of advanced sequences with multiple steps, offering greater flexibility in managing lighting behavior over time.

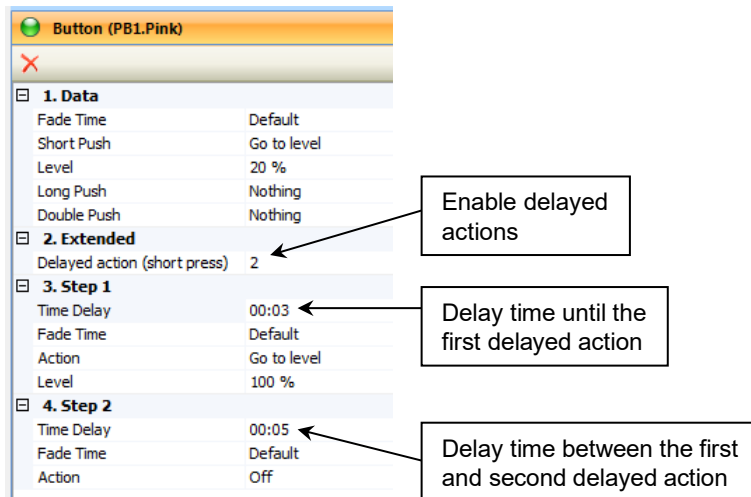

Option	Description	Parameters/Examples
<b>Time Delay</b>	Step 1: Delay time until the first delayed action starts. Step 2: Delay time between the first and the second delayed action.	No 1 2
<b>Fade Time</b>	Duration to dim to the new brightness level.	Default, No fade, 0,7s- 90.5s
<b>Action</b>	Delayed action type: - Off - Go to level	Level (0,1 – 100 %)

#### 4.2.4 Create light scenes

Light scenes are used when ECGs within a group need to switch to different light levels following an action. The specific light values for each scene are stored directly in the ECGs. This ensures that all ECGs switch on simultaneously, but it also limits the number of scenes that can be created due to the storage capacity of the ECGs.

Scenes are created in the **Scenes panel**. To begin, you must first select either the relevant group (1) or the associated function collection (2) in the **Graphic panel**.

A new scene can then be created for this group in the Scene Panel (3).

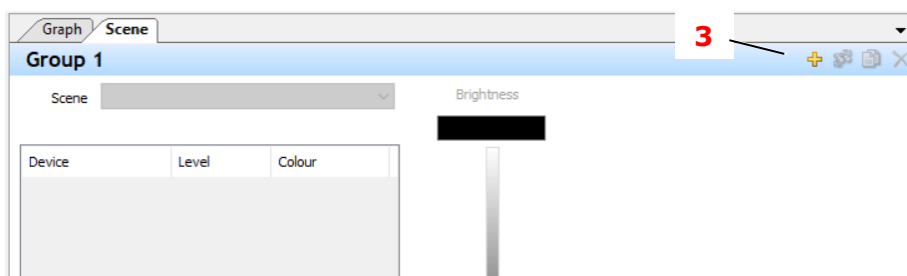

If the Scene Panel is not visible, it can be made visible via the menu (4).

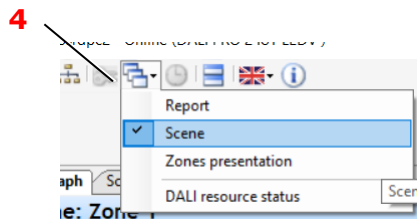

Each scene is given a name (5) that can be used later to integrate it into the functions.

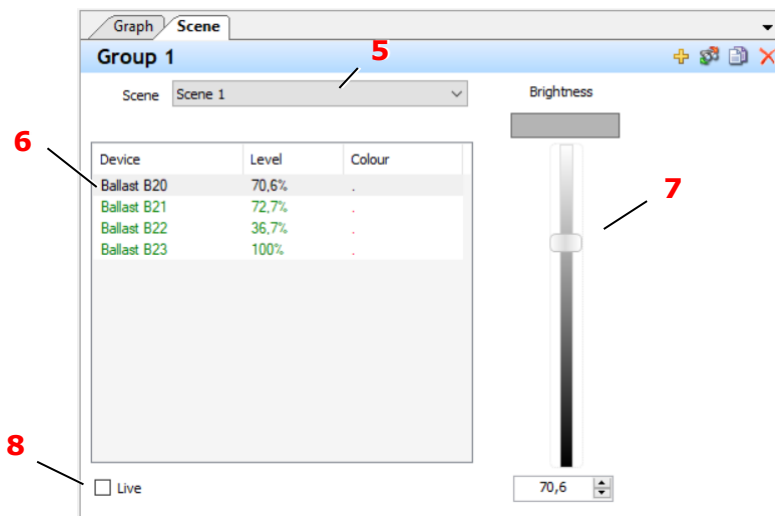

After selecting the scene to be edited from the drop-down list, the light values of the selected ECGs can be set from the list (6) using the slider (7). Multiple selection is possible using the Shift or Ctrl key. If the "Live" field (8) is activated, the currently set values are displayed visually with the actual ECGs.

The scene values are only stored in the ECG when a scene is actually used. An ECG can store a maximum of 16 different scenes.

#### 4.2.4.1 Reserve scenes

Scenes are only stored in the ECG if they have been used in a function. However, the IoT interface of the DALI PRO 2 IoT also allows scenes to be called up directly via IoT API functions. To reserve a scene for this purpose, drag the "Scene Reservation" device from the device display (1) into the function group.

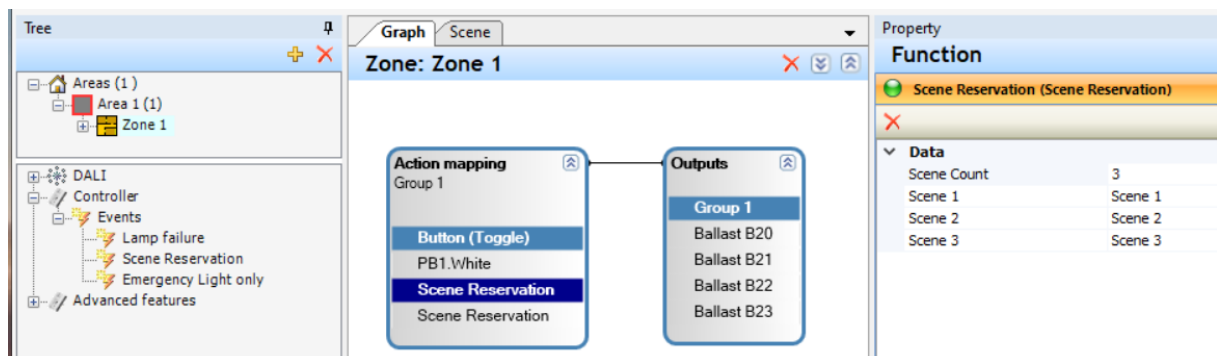

The number of scenes to be reserved (2) can be set in the function. The scenes to be used are then defined (3).

#### 4.2.5 Central control function

The central function allows for reusing the same button across different action mappings by implementing clear on/off functions. In this scenario, the detail parameters for each action mapping can vary, providing flexibility in functionality.

A toggle function is also available, ensuring that all outputs connected to the same button are synchronized. The toggle rule states that if any light is on in any connected output, pressing the button will turn all lights off; otherwise, it will turn them on.

It's important to note that the toggle function is most effective when all lights are visible to the user while operating the button. Otherwise, it may lead to confusion about the lights' status.

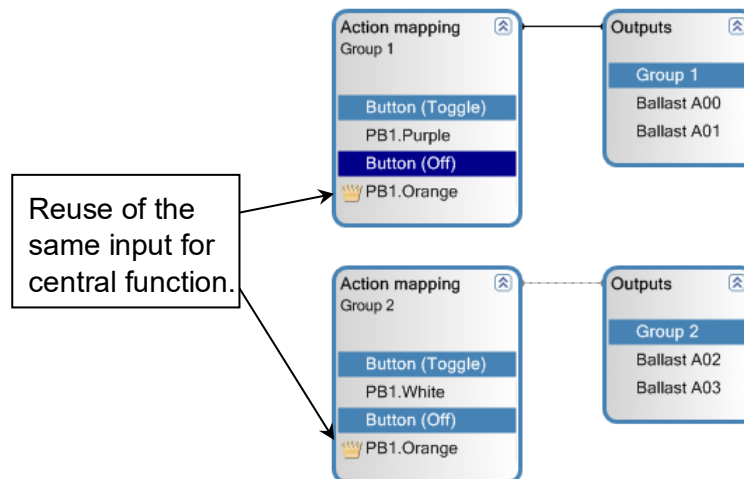

#### 4.2.6 Overlapping groups

Reusing the same ECG in different groups is beneficial only for optically overlapping groups and not for central functions.

For example, consider two areas with three lamps, where one lamp is shared between both areas. This lamp will follow these rules:

- If either area is turned on, the shared lamp will also be on.
- If both areas are turned off, the shared lamp will also be off.

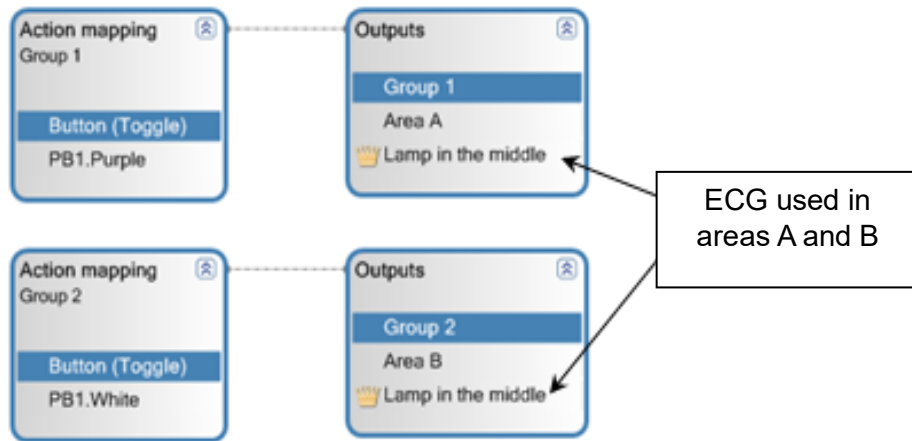

This behavior applies similarly when motion detection sensors or light regulation systems are utilized.

Additionally, it is possible to have a separate button for the shared lamp, governed by the following rules:

- If all lamps are off, pressing the button for the shared lamp will turn it on. If either Area A or Area B is then activated, and the last activated area is off, the shared lamp will also be turned off.
- If either Area A or Area B is on (along with the shared lamp) and the shared lamp is turned off separately, it will remain off until both Area A and Area B are also turned off, which will reset this special state.

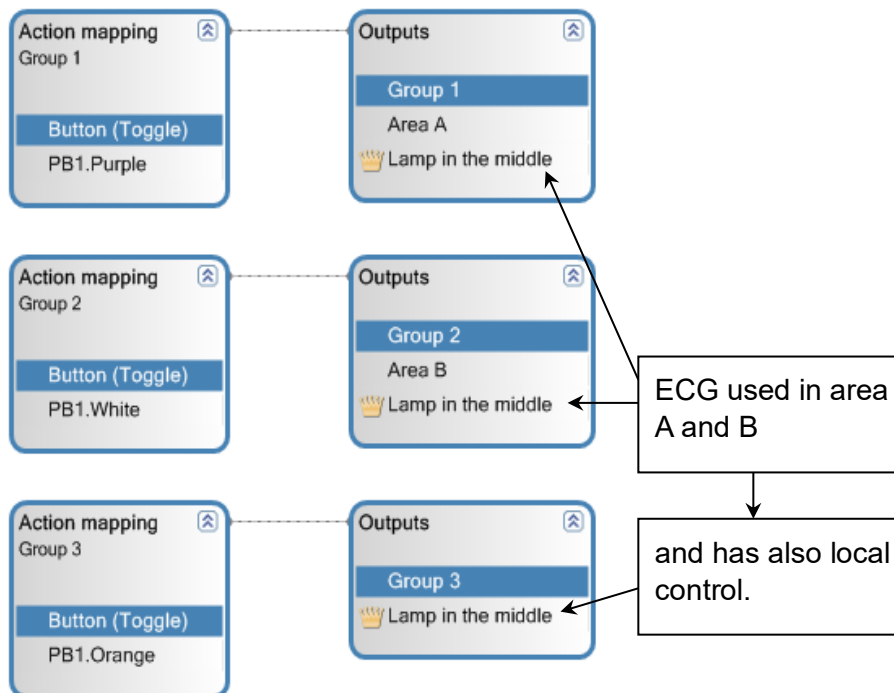

### 4.3 Motion detection

Motion detection enhances lighting systems by automatically activating lights when movement is detected, ensuring spaces are well-lit when occupied. The system can adjust light intensity based on activity levels, trigger specific lighting scenes, and integrate with other systems like alarms for improved security. Users can customize time delays for how long lights remain on after motion ceases, providing convenience and energy efficiency while adapting to user needs.

#### 4.3.1 Functionality

Different reactions can be configured for motion detection:

Mode	Description
<b>Fully automatic</b>	When motion is detected, the light turns on. After the run-on time elapses, the light automatically switches off.
<b>Fully automatic - One level (lowering)</b>	When motion is detected, the light turns on. After the run-on time expires, the brightness is reduced to the standby level. After the second run-on time elapses, the light turns off.
<b>Fully automatic - Two levels (lowering)</b>	When motion is detected, the light turns on. After the run-on time elapses, the brightness is reduced to the standby value. In a subsequent step, the light is further dimmed. Finally, after the second run-on time elapses, the light is switched off.
<b>Semi-automatic</b>	The lighting can only be switched on manually, but motion detection extends the lighting duration accordingly.  The light is switched off after the run-on time has elapsed.
<b>Semi-automatic - One step (lowering)</b>	After manually switching on the lighting, the duration is extended when motion is detected. Once the run-on time elapses without further movement, the system reduces to standby level. After the second run-on time elapses, the light is switched off."
<b>Semi-automatic - Two stages (lowering)</b>	After the lighting is switched on manually, the duration is extended when motion is detected. Once the run-on time elapses without further motion, it reduces to standby level. After the second run-on time elapses, the light switches off

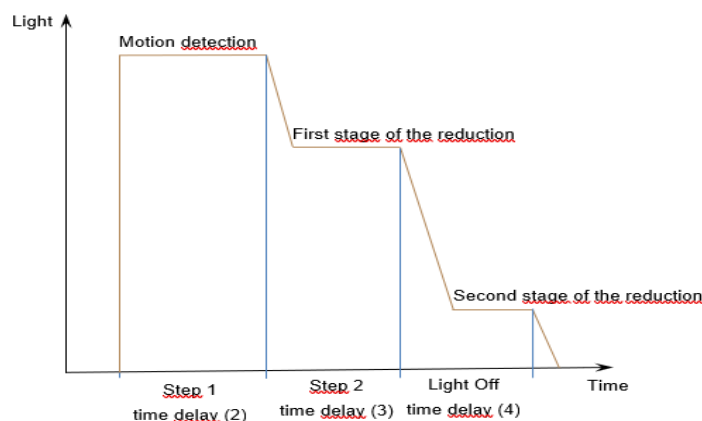



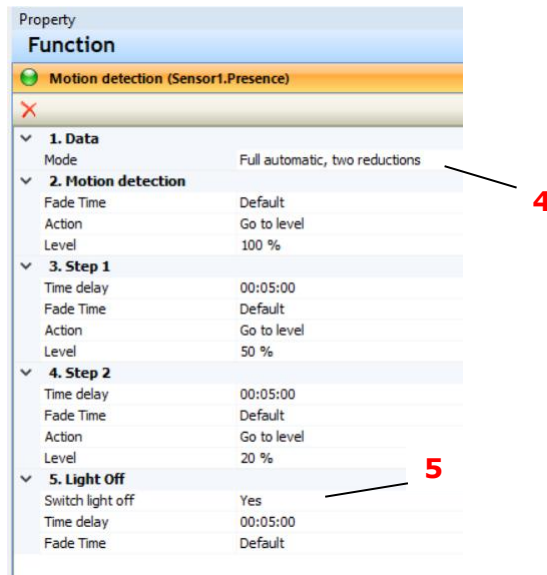

The light-off function can optionally be deactivated (5) so that the light value remains permanently at the reduced brightness level.

### 4.3.2 Push button and motion detection

Normally, when the light is turned on via a push button, the motion detection sequence is activated, causing the light to turn off automatically after a set delay when the last person leaves the room. If the light is manually switched off, motion detection is blocked for 30 seconds, with an additional 30-second extension added each time motion is detected, preventing automatic activation when someone exits. This behavior can be modified through specific configurations.

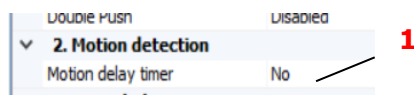

To keep the light permanently on after activation via the push button, set the 'Motion delay timer' property (1) to 'No', requiring manual shutoff. If motion detection is blocked after activation, the option 'Motion detection can change light' (2) becomes available.

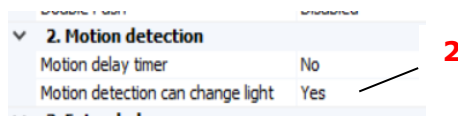

Typically, motion detection does not affect lights that are already on. However, if 'Motion detection can change light' is set to 'Yes' and the light was activated by the push button, it will adjust to the configured value for motion detection. This allows for scenarios where lights can be dimmed for orientation and switch to full brightness when motion is detected in specific work areas. Additionally, the behavior of motion detection after the light is turned off can be customized using the 'Motion detection after light off' property (3).

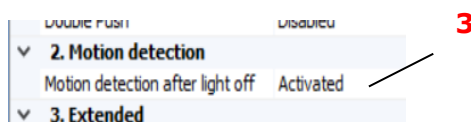

There are three possibilities:

Value	Description
<b>Blocked</b>	Motion detection is blocked, and the light is not switched on automatically. This block remains in effect until the next action (e.g., pressing another button). After that, the behavior of the function resumes as configured.
<b>Activated after 30 s</b>	By default, the motion sensor activates after 30 seconds, allowing time to leave the room
<b>Activated</b>	The motion sensor is activated immediately. This is recommended if the switch is outside the detection range of the motion sensor.

This property is only displayed if the light is switched off by the function.

These options for the light functions by short press or double press, apply to each push-button.

### 4.3.3 Lock motion detection via button, time functions, sequence control

When using a motion sensor, additional functions are available on the push-button for both short press (including delayed actions) and long press, as well as for time events and sequence control (1).

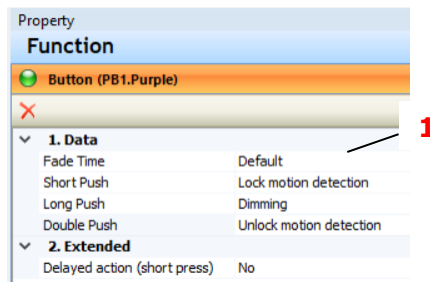

These functions can be used to block or unblock motion detection. The block remains active until it is released by another action. These functions take precedence over the configured motion detection behavior, including the light on/off functions.

Short print/long print	Description
<b>Disable motion detection</b>	The function of the motion sensor is suppressed, meaning the light is not switched on or off automatically
<b>Lock motion detection and light off</b>	The function of the motion sensor is suppressed, meaning the light is not switched on or off automatically. Additionally, the light remains off.
<b>Enable motion detection</b>	The motion sensor function is re-enabled. If the light is on, it will be switched off after the set times for the motion sensor function have elapsed.

### 4.3.4 Lock motion detection via switch

The function of a switch can be changed to "Lock switch for motion sensor" (1).

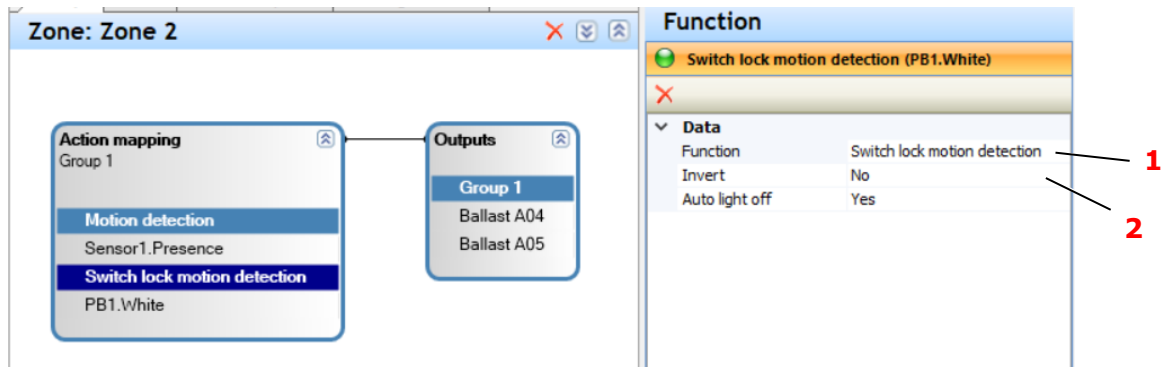

If the 'Inverted' property (2) is set to "No," the motion sensor function is disabled when the switch is turned on. This means the light will not be automatically turned on by the motion sensor. Additionally, if the light is already on, the timer for automatically switching it off is also stopped.

If the 'Inverted' property is set to "Yes," the switch must be turned on to enable the motion sensor. For example, to ensure the light turns off when the motion sensor is disabled, set the 'Auto light off' property to "Yes." In this case, the light will switch off when the motion sensor is disabled.

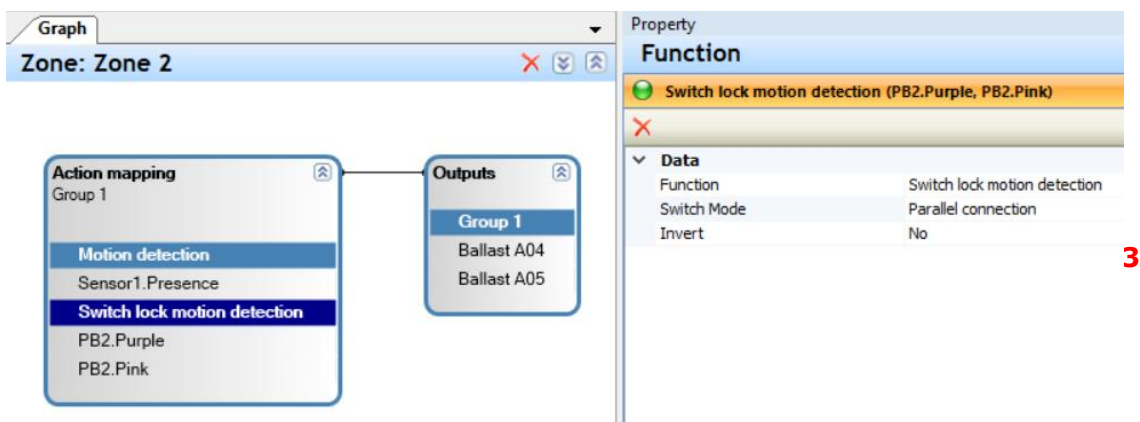

Using the example of two switches, the following possibilities arise with the different configurations:

S 1	S 2	Parallel Inverted = No	Parallel Inverted = Yes	Serial Inverted = No	Serial Inverted = Yes
From	From	active	locked	active	locked
To	From	locked	active	active	locked
From	To	locked	active	active	locked
To	To	locked	active	locked	active

## 4.4 Light control

The DALI PRO controllers offer sophisticated daylight harvesting methods to optimize natural light usage, enhancing user comfort while reducing energy consumption. The following chapters describe the various options and possible settings.

### 4.4.1 Parameters

Three parameters are important for light regulation.

Parameters	Description	Remark
<b>Control value</b>	<b>The relative light value corresponds to the installed power and reflects the ECG dimming value in situations without daylight. This ensures that the light output matches the desired brightness level.</b>	<b>For example, if set to 80%, despite aging of the light sources, the brightness remains regulated to match the brightness specified during initial installation.</b>
<b>Calibration sensor value</b>	<b>The result of the calibration procedure. It is the percentage sensor value achieved by the lights alone.</b>	<b>The sensor difference value is derived from measurements with the lighting switched on (set to 100%) and switched off. Ideally, this value should fall within the range of 10% to 30%.</b>
<b>Geometry factor</b>	<b>Numerical value to describe the influence of the room geometry on the control.</b>	<b>If the brightness is too low during daylight, increase the value. If the brightness is too high during daylight, reduce the value.</b>

#### Notes:

- The lower limit of the calibration value depends on the sensor's resolution; it should still provide significant resolution in the low number range (e.g., 3% is possible with the LS/PD-LI sensor).
- The upper limit of the calibration value, multiplied by the geometry factor, should be less than 100%. If the calibration value is too high, the sensor may reach 100% too early in daylight, which is considered sufficient light (lights dim down).
- If the calibration value falls outside the optimum range, consider adjusting the sensor's position. Some sensors may allow sensitivity adjustments (e.g., "High Bay Adapter").

### 4.4.2 Calibration

Calibration should be conducted under conditions of minimal or no daylight. Excessive daylight can overload the sensor, causing the sensor value to reach its upper limit of 100%.

The calibration dialog can be accessed via the icon (1) in the control function for the currently selected control.

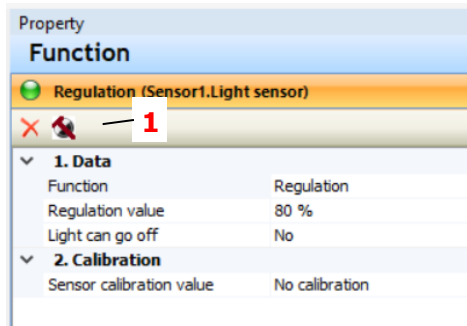

It is also possible to open the dialog via the icon (2) in the device display after selecting Coupler for all controls. The regulations are displayed in a list (3) in the dialog.

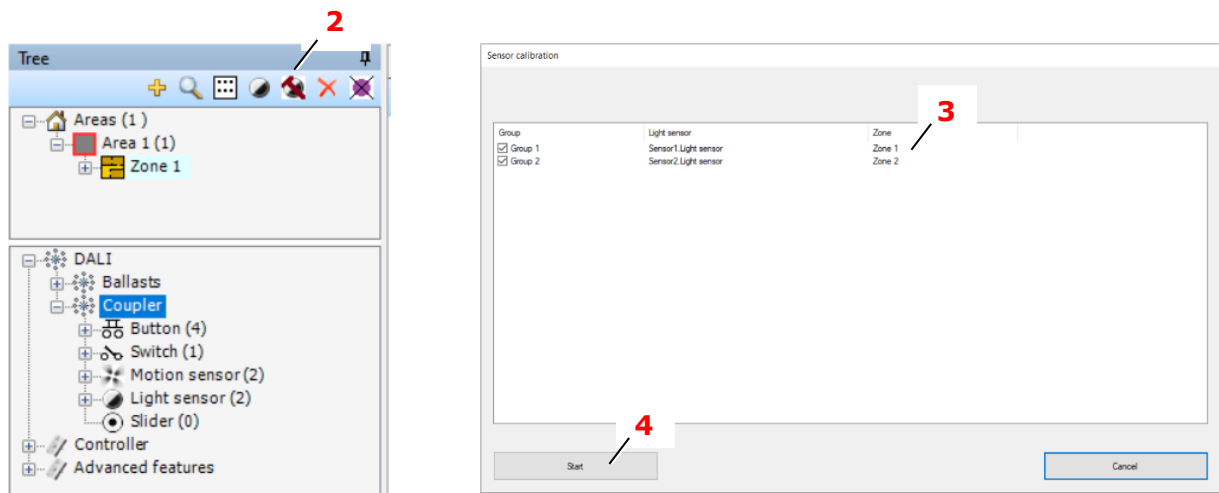

All selected controls are calibrated one after the other after clicking on the button (4). If calibration is not possible, a corresponding error message is displayed.

#### 4.4.2.1 Set control value

The desired control value can be entered directly in the control properties (1).

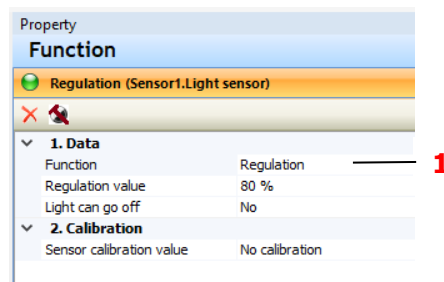

The test function can be used to interactively set the control value. This must be done without daylight.

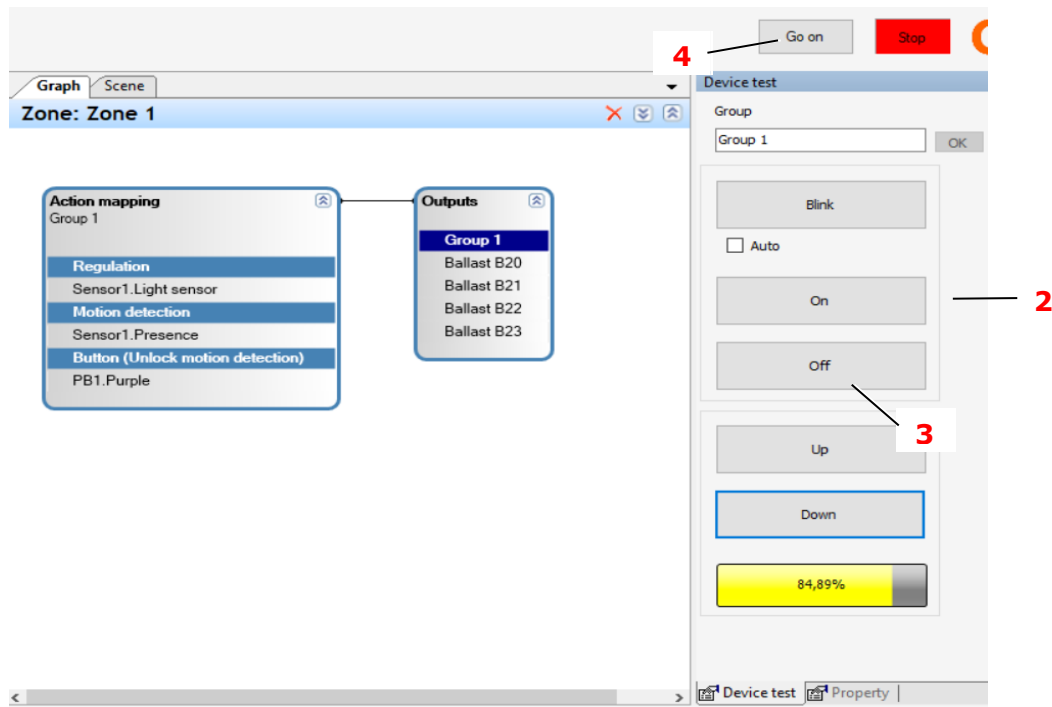

After selecting the group, control, or function collection in the Graph panel, you can adjust the brightness of the light group using the "Up" and "Down" buttons (2). If the lights are off, then the "Up" button starts at 100%, while the "Down" button starts at the minimum light value (typically 1%).

Once you've achieved the desired brightness, **double-click** on the displayed light value (3) to confirm it as the control value. If applicable, a dialog will appear to finalize the selection, which must be confirmed.

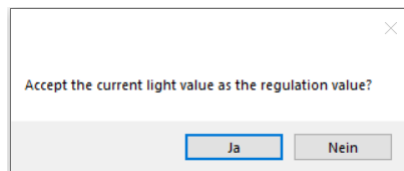

During this process, the lighting control is stopped and must be restarted manually by clicking on the "Go on" button (4).

### 4.4.3 Automatic light "ON" and "OFF" switching

Optionally, the light can be automatically switched off when there is sufficient daylight by setting the "Light can go off" property to "Yes" (1). After dimming to the minimum light value, the light stays at this level for the configured time period before being turned off.

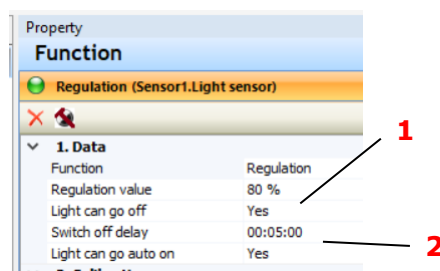

It is also possible to switch the light on again automatically if the brightness in the room falls below the set value by setting the "Light can go auto on" property to "Yes" (2).

If no motion sensors are used at the same time, it should be ensured that the light is actually switched off, e.g. by a push-button, when the room is left in the temporarily switched-off state.

#### 4.4.4 Control with multiple sensors

If multiple sensors are utilized in a control system, they should be of the same type, mounted geometrically similarly, and provide approximately the same individual calibration sensor value. These individual values are displayed in the calibration dialog:

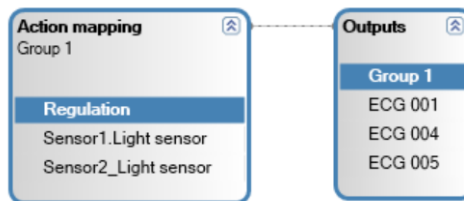

You can use the sensors as an average value or the minimal value.

The screenshot shows the 'Function' property panel with the following settings:

- 1. Data**
  - Function: Regulation
  - Regulation value: 80 %
  - Light can go off: No
  - Geometry factor: 2,8
  - Tolerance: 10 %
  - Level max: 100 %
  - Level min: 1 %
  - Sensor combination: Average value
- 2. Calibration**
  - Sensor calibration value: Minimal value

**Sensor calibration**

Regulation	Result	Sensor value	Comment
Zone 1 (Sensor1.Light sensor, Sensor2.Light sensor -> Group 1)	OK	3,6%	Sensor1.Light sensor = 1,4 % Sensor2.Light sensor = 5,9 %

The individual calibration values are also displayed in the sensor properties.

Random address	14-139-34
Port	B
Short address	0
Instance	1
<b>3. Usage</b>	
Used in zones	Zone 1
Sensor calibration value	5,9 %

### 4.4.5 Regulation and offset groups

If the regulation is connected to two groups, one group can be set as an offset group.

The screenshot shows the configuration for Group 2. On the left, the 'Action mapping' panel for Group 1, Group 2 includes 'Regulation' and 'Sensor1.Light sensor'. The 'Outputs' panel for Group 1, Group 2 includes 'Group 2 (-20 %)', 'Ballast A02', and 'Ballast A03'. On the right, the 'Group 2' configuration window is open, showing the following settings:

1. Data	
Title	Group 2
Comment	
Offset Group	Yes
Offset	-20 %
Dynamic	Yes

2. Gear Properties	
System failure behaviour	Default
Power on behaviour	Default
Level min	1 %
Level max	100 %

3. Using	
Use in zones	Zone 1

Annotations in the image:

- An arrow points from the 'Offset Group: Yes' and 'Offset: -20 %' row to a callout box: "Offset value between the two groups."
- An arrow points from the 'Dynamic: Yes' row to a callout box: "If yes, the offset is zero with no day light and the set value with maximum day light."

The offset value remains constant when the "Dynamic" parameter is set to "Yes." Otherwise, it dynamically adjusts between zero (in the absence of daylight) and the set offset value (at maximum daylight).

An ECG that is already part of an offset group cannot be assigned to any other group.

### 4.4.6 Dynamic change of regulation value

The "dynamic change of the regulation value" feature allows regulation values to be adjusted via a button press or switch state change. The new value permanently overwrites the previous one from the regulation setup.

The screenshot shows the configuration for Group 1. On the left, the 'Action mapping' panel for Group 1 includes 'Button (Set regulation value)' and 'Regulation'. The 'Outputs' panel for Group 1 is also shown. On the right, the 'Button (PB1.Orange)' configuration window is open, showing the following settings:

1. Data	
Fade Time	Default
Short Push	Set regulation value
Regulation value	60 %
Long Push	Dimming
Double Push	Nothing

  

2. Extended	
Delayed action (short press)	No

An annotation in the image:

- An arrow points from the 'Regulation value: 60 %' row to a callout box: "With button press the new regulation value is valid"



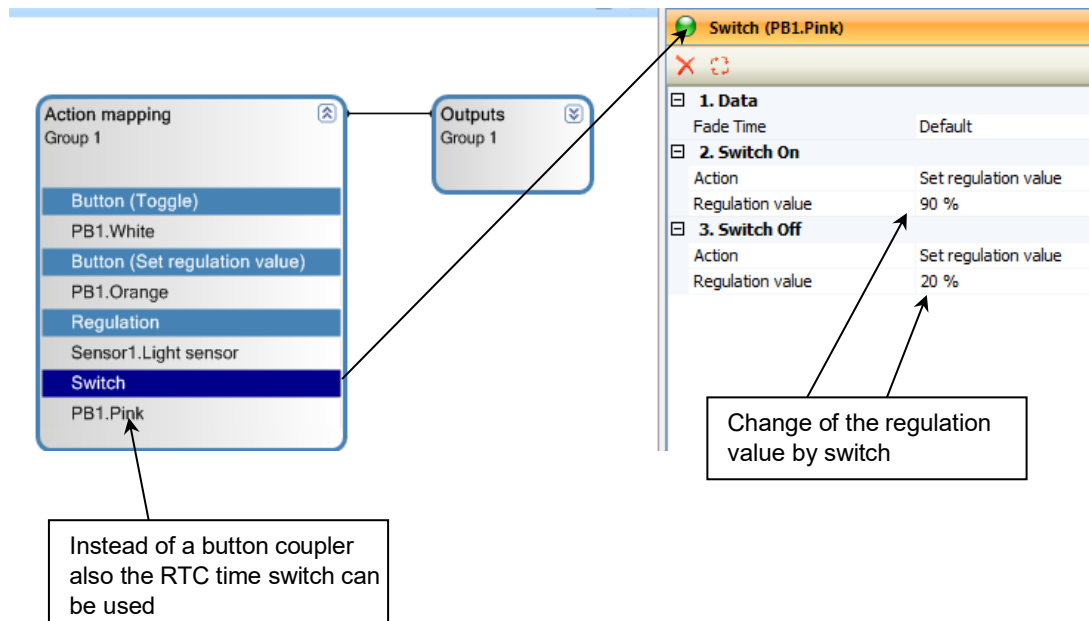

The switch function can also be connected to the RTC time switch for time-dependent changes to the regulation value.

Whenever the light is turned on to regulate, the current set regulation value is applied. If the light is already on and the regulation is active, any change to the regulation value will gradually adjust the light to the new value within the normal regulation loop.

#### 4.4.7 Twilight function

In addition to using the light sensor for regulation, the twilight function is also available. When a light sensor is connected to the light outputs, the regulation function is automatically generated. From this, users can switch to the twilight function

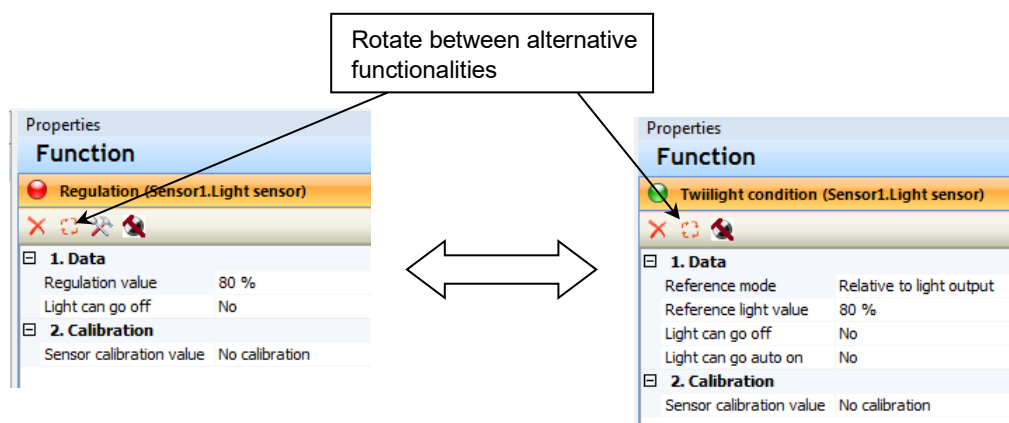

The twilight function controls the on/off state of the lights based on the ambient light conditions. Combined with motion detection, it allows the lights to turn on only when motion is detected, and the light levels are too low.

There are two types of light level setup, depending on whether the sensor can detect its own light output or not.

### 4.4.7.1 Light setup: Relative to light output

If the sensor detects its own light, it must be calibrated accordingly. The calibration process is the same as for light regulation. The reference light value can be set relative to the maximum light output (100%), and the system will maintain this as the minimum light level. If the feature "Light can go auto on" is enabled, the "Reference light value" will be used to turn on the lights.

The screenshot shows the configuration for a "Twilight condition (Sensor1.Lig)" in "Zone: Zone 1". It includes an "Action mapping" for "Group 1" using "Sensor1.Light sensor" and "Outputs" for "Group 1" including "Ballast B00". The configuration table is as follows:

1. Data	
Reference mode	Relative to light output
Reference light value	80 %
Light can go off	Yes
Switch off delay	05:00
Light can go auto on	Yes
Switch on delay	00:00
Fade Time	Default
2. Calibration	
Sensor calibration value	No calibration

Callouts in the image provide the following explanations:

- "Minimal accepted relative light level (10% ... 100%)" points to the "Reference light value" field.
- "To enable to automatically switch off with enough light for the selected time" points to the "Light can go off" field.
- "Calibration of the light sensor to the maximal possible light output (100 %)" points to the "Sensor calibration value" field.
- "To enable to automatically switch on if there not enough light for the selected time" points to the "Light can go auto on" field.

### 4.4.7.2 Light setup: Absolute sensor value

In cases where the sensor does not detect its own light, the "Absolute sensor value" mode should be used. The test function helps establish the "Reference sensor value" based on the minimum acceptable ambient light level for switching on the lights.

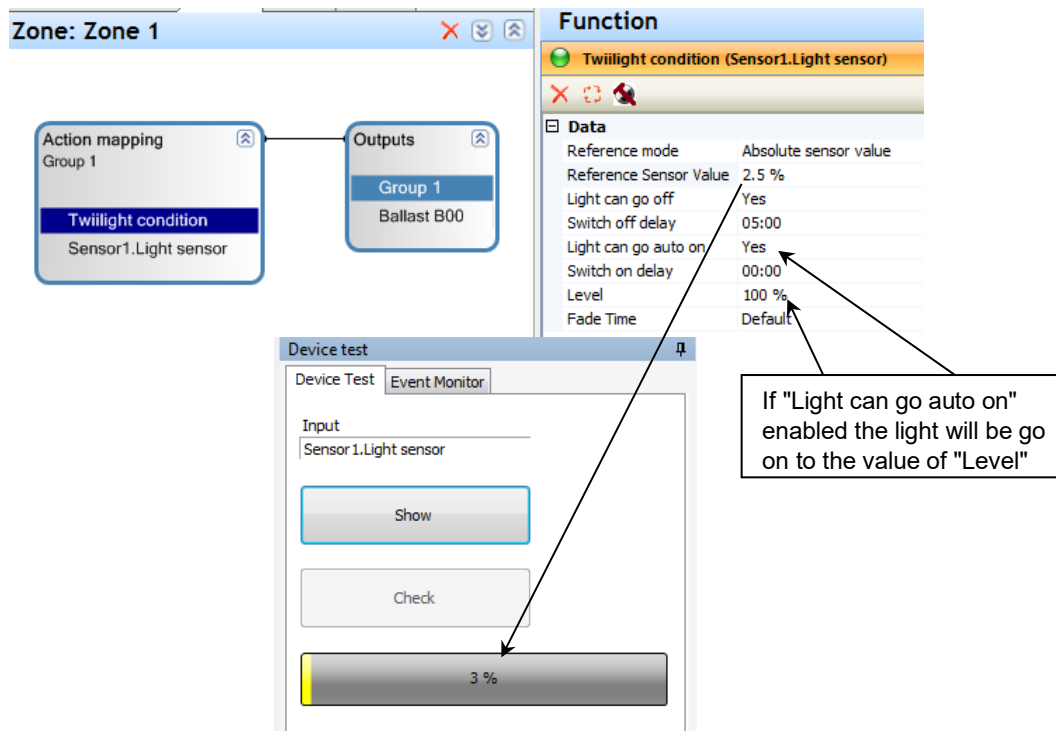

## 5 Color Control (RGB/W)

### 5.1 General

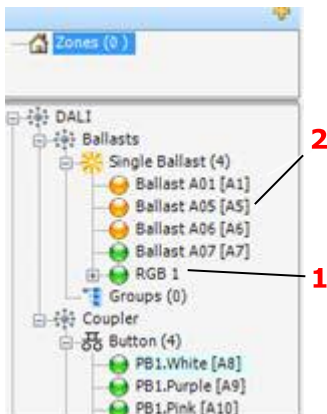

To control colored light, an RGB/W device must be created by combining three/ four DALI ECGs, each for red, green, blue /and white light.

For RGB/W functions, you can use combined RGB/W (1) devices and/or 4-channel DT8 devices.

The individual ECGs within a combined RGB/W device are shown in orange (2) and are no longer usable.

**NOTE:** The DALI Device Type 8 for colored light is not supported by the DALI PRO-Cont4 RTC controller!

### 5.2 Add RGB/W device and configure basic settings

#### 5.2.1 Adding RGB/W device

In order to add an RGB/W device to your project, follow these steps:

In the device tree, right-click **ECGs > Single ECG > Add devices**.

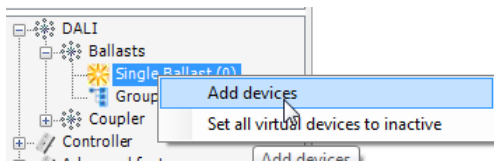

Select the number of RGB/W devices and confirm.

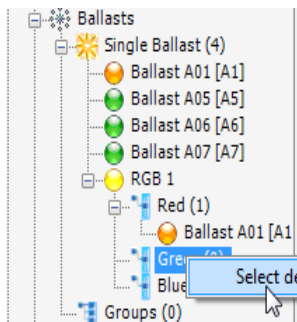
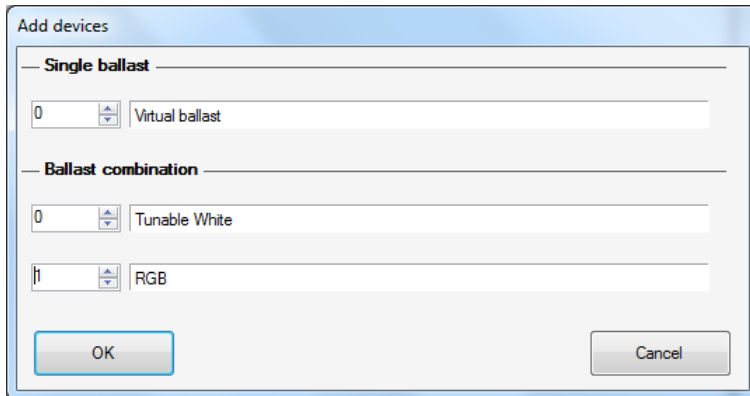

The single-colored ECG's can be put direct into the red, green or blue group components by drag and drop. Alternatively, you can expand the RGB group in the device tree to select the available devices.

The ECGs that are not already used in other groups, or ECGs used in this group will be shown in the list.

Drag the device from the device tree into the Graph Panel.

### 5.2.1.1 RGB device generation from the localization dialog

The localization dialog is only visible when connected to the DALI PRO controller. To open the localization dialog press "Scan for devices" in the ballasts section. If you have already scanned for devices, you can directly open the dialog via the "Locate devices" icon .

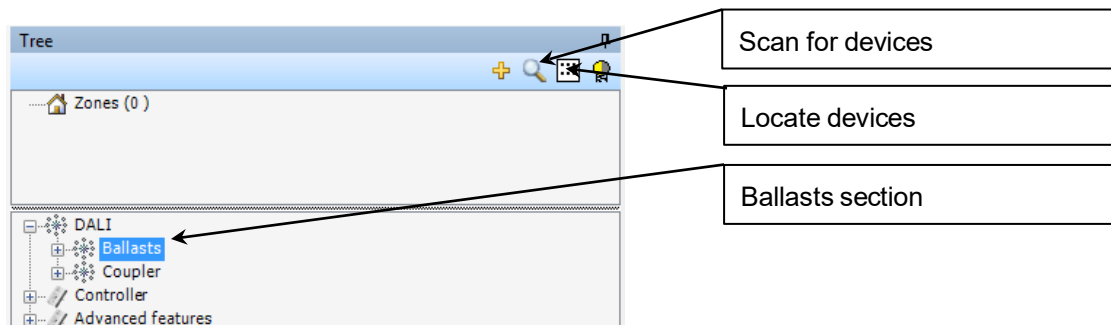

Open the Group register and choose the RGB mode

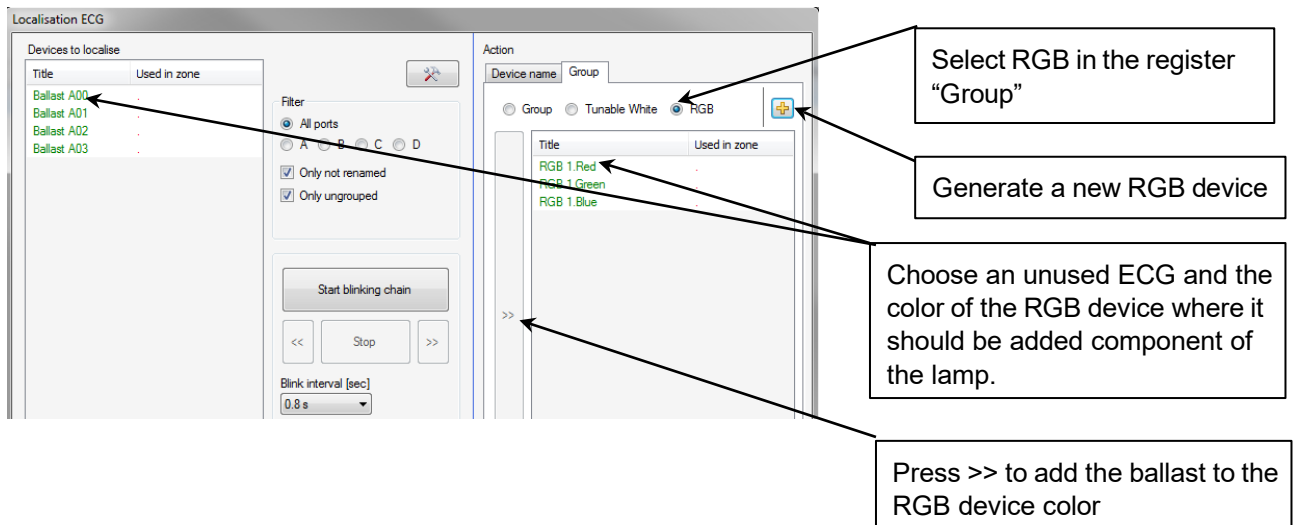

The connected DALI ECG's can be easily selected by blinking and then added to the respective RGB device color.

### 5.2.2 Using RGB/W in the application.

In the application, only the combined device (RGB group) will be used. The single ECGs will appear in orange and will no longer be directly useable.

You can drag and drop the RGB group into the graphic panel and connect it with an input device, e.g. a push button.

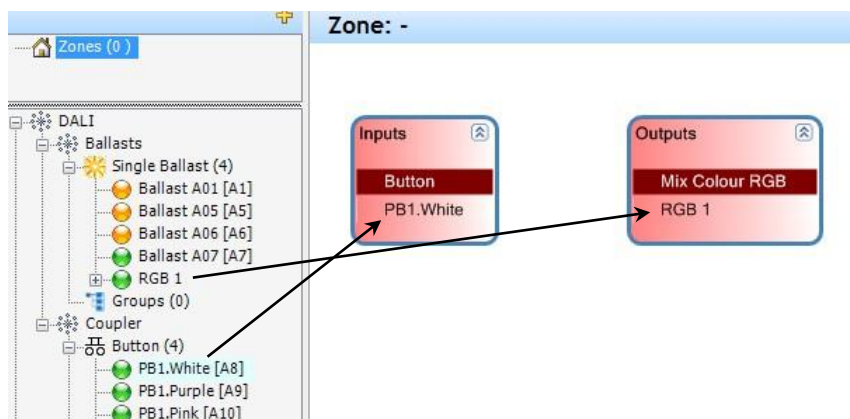

#### 5.2.2.1 Configuration settings

There are several configuration settings for RGB devices available. To access them, select the RGB/W group and configure the device in the Properties window.

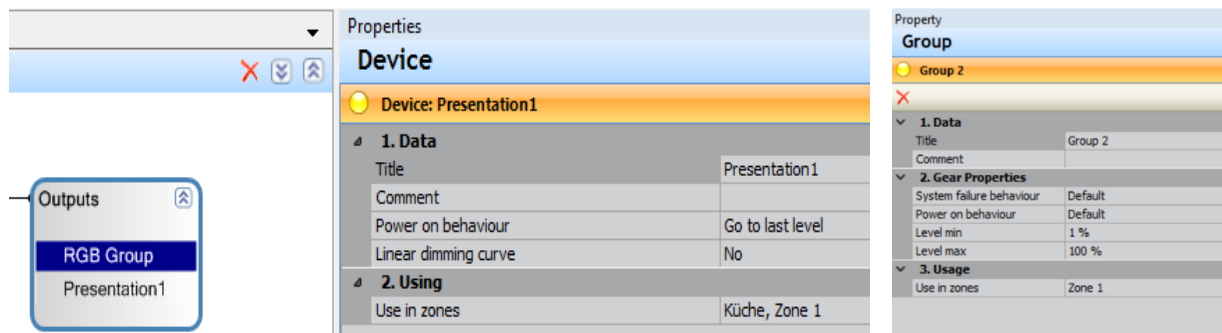

Option	Description	Parameters/Examples
<b>Title</b>	Rename the RGB/W device.	e.g. Foyer RGB light wall 1
<b>Comment</b>	Add a comment for further information.	e.g. device located above luminaire
<b>Power on behavior</b>	Light on situation: - Go to last level: Light on – with values from the situation before the power loss - Go to level: light level after power cycle	Power On Level (0 – 100 %) Color (RGB/W settings), see 4.3.7 <i>Setting a color value</i>
<b>Linear dimming curve</b>	When enabled, this mode prevents changes in light intensity during dynamic color adjustments. Optimized for RGB/W devices.	No Yes
<b>Used in zones</b>	Lists zones, where RGB/W device is used.	e.g. conference room

### 5.3 Add and configure buttons

#### 5.3.1 Adding buttons

Button actions are typically combined to make full use of available functionalities.

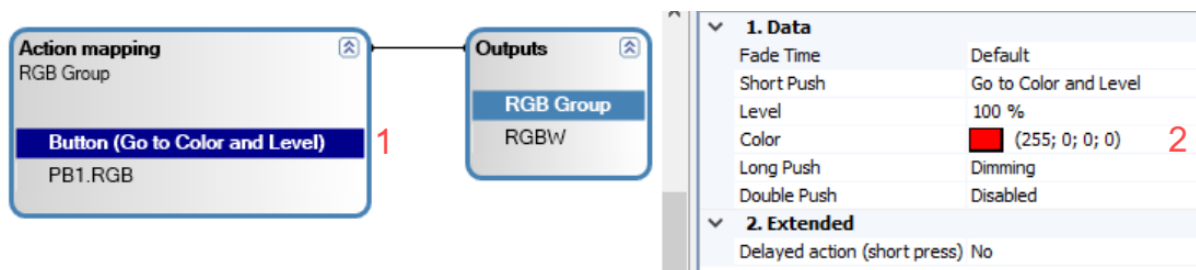

- In the Graph panel, connect the RGB device (Inputs) to the button (Outputs): Click on Inputs and drag the mouse to Outputs. A connector line will appear, and the title "Inputs" will change to Action Mapping.
- Select a button function (1).
- Configure the button in the Properties window (2). Refer to the relevant description tables for more details.

Option	Description	Parameters/Examples
<b>Fade Time</b>	Duration to dim to the new brightness level.	Default (uses fade time stored from the ECGs) No fade 0.7 – 90.5 s
<b>Short push</b>	Select action for a short push of a button.	See 3.2.1.1 <i>Short push actions</i>
<b>Long push</b>	Select action for a long push of a button.	See 3.2.1.2 <i>Long push actions</i>
<b>Double push</b>	Select action for a double push of a button.	See 3.2.1.3 <i>Double push actions</i>
<b>Delayed action</b>	Define up to two delayed actions for a Short push. If one or two actions will be configured, the additional properties for each action will be displayed (See the following tables).	No 1 2

### 5.3.2 General settings

Clicking on the Button element inside the Action Mapping window will display the following options in the Properties window:

### 5.3.3 Delayed action configuration options

Option	Description	Parameters/Examples
<b>Time Delay</b>	Step 1: Delay time until the first delayed action starts. Step 2: Delay time between the first and the second delayed action.	No 1 2
<b>Fade Time</b>	Duration to dim to the new brightness level.	Default, No fade, 0,7s- 90.5s
<b>Action</b>	Delayed action type: - Off - Go to level	Level (0,1 – 100 %)

### 5.3.4 Short push actions

See chapter 3.2.1.1

### 5.3.5 Long push actions

See chapter 3.2.1.2

### 5.3.6 Double push actions

See chapter 3.2.1.3

### 5.3.7 Setting a color value

All RGB/W values can be manually entered for the devices. Each color is a combination of RGB/W values.

To set a color value for one or more button actions, use one of the following options:

**Option 1:** Click the list (1) to open the RGB circle, select a color, and confirm with OK.

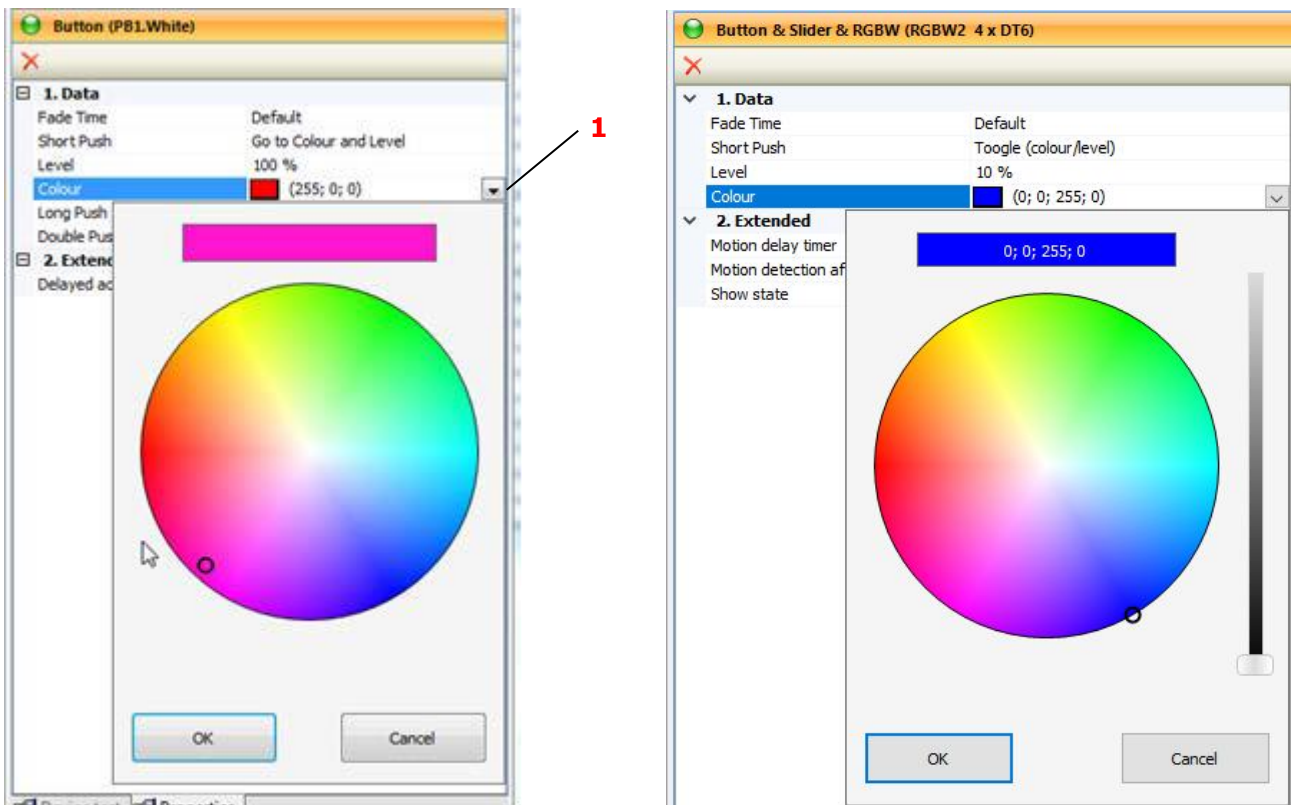

**Option 2:** Enter the exact values (2) for Red, Green, Blue, and White, such as for specifying precise corporate color values.

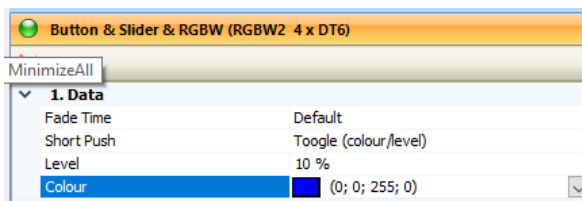

### 5.4 Add and configure a colored scene

In addition to light level control, color control for each RGB/W output will be displayed in the scene panel. A single button can also be configured to cycle through up to five scenes (short push > next scene).



### 5.4.1 Adding a colored scene

1. Select the desired Action Mapping box in the Graph Panel to choose the outputs that will be affected by the scene.

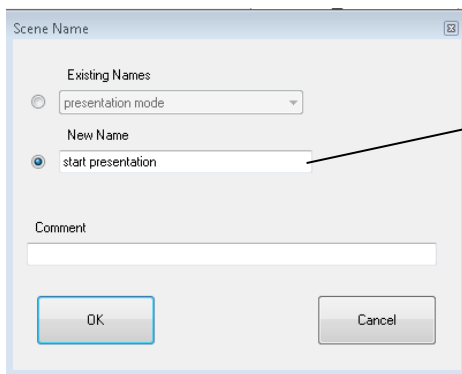
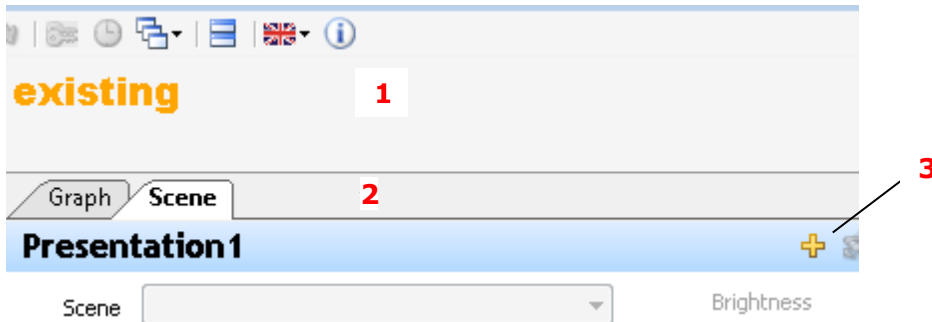

2. Click the list (1) and activate the Scene tab (2).
3. Click the + (3) to add a new scene.
4. Rename the scene (4) in the pop-up window.
5. Click „OK” to confirm.

### 5.4.2 Configuring a colored scene

In the scene panel, all devices affected by this scene are listed.

Each device in the list can have different brightness and color levels, or they can share the same settings. RGB/W and standard ECGs can be combined within the same scene.

1. Select the desired device(s) (1). Hold [Shift] or [Ctrl] to select multiple devices.
2. Choose the color values (2).
3. Set the brightness level (3).
4. If connected to the controller, activate Live (4) to visualize your selection. After finalizing your selection, click Go On (5) to reactivate the configuration.

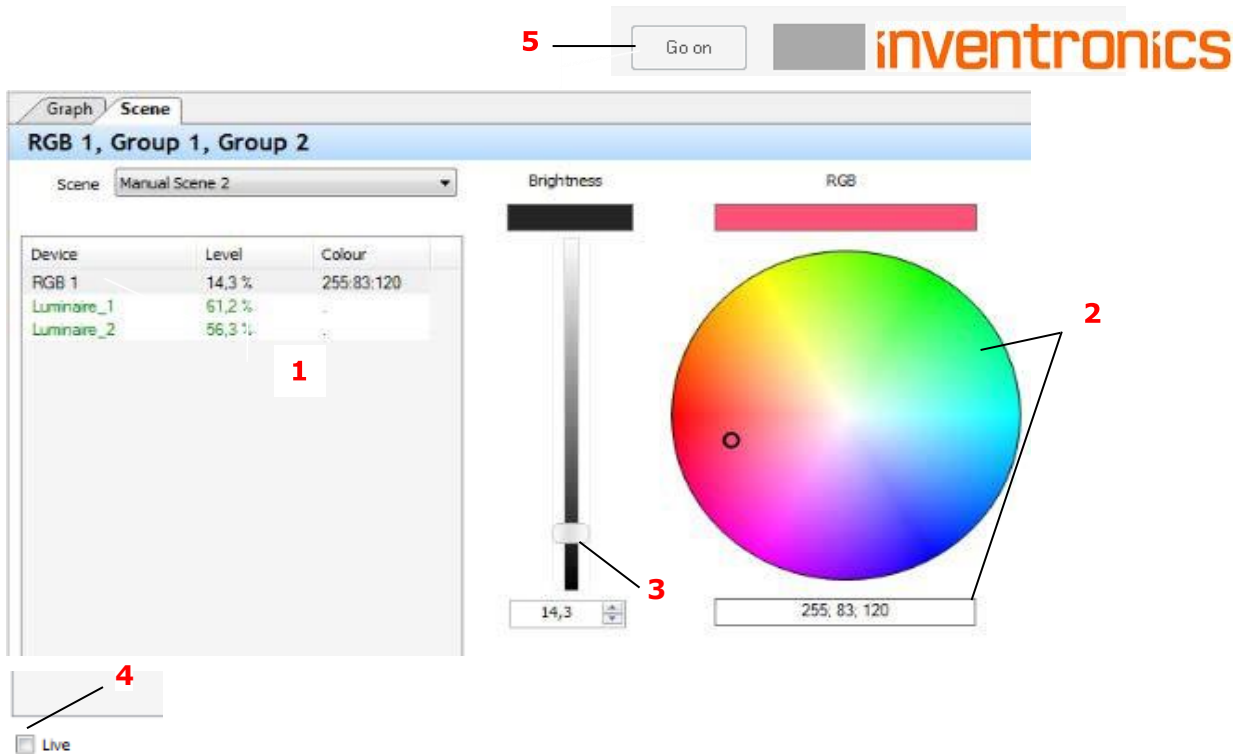

### 5.4.3 Recalling a scene

To recall a scene using a push button, follow these steps:

1. Select the button function in the Graph Panel (1).
2. In the Properties window, choose: **Short push > Go to scene** (2).
3. Select the desired scene (3).

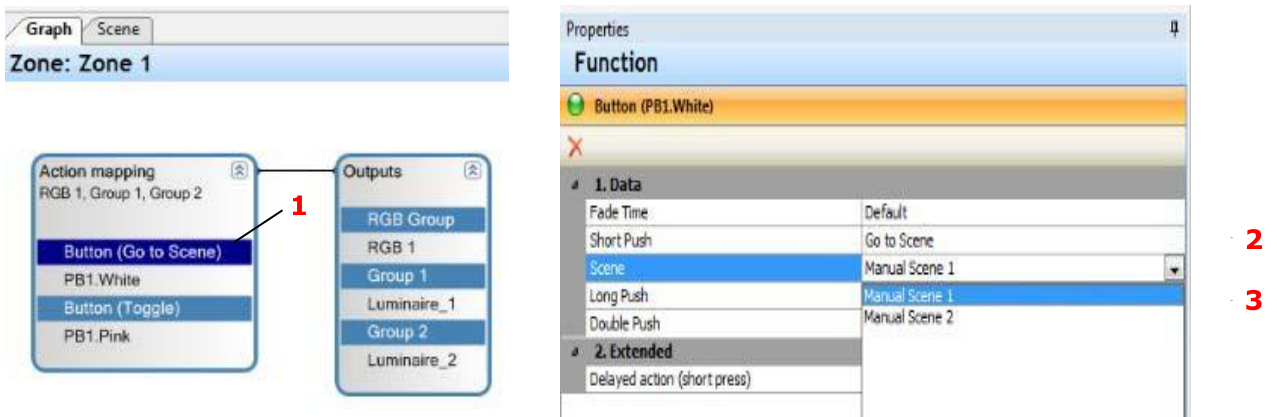

## 5.4.4 Recalling multiple scenes

One button function can be used to toggle between multiple scenes

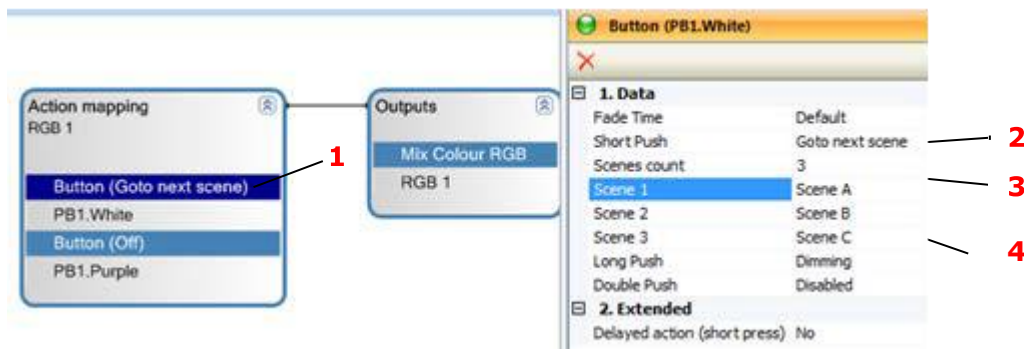

1. Select the button function in the Graph Panel (1).
2. Select: *Short push* > *Go to next scene* (2) in the Properties window.
3. Select the number of scenes for the loop (3).
4. Select the names of the scenes (4).

## 5.5 Add and configure a Color Effect (RGB/W profile)

The Color Effect offers the following functionalities:

- Play an RGB/W profile.
- Easily enable continuous color changes through a few steps:
  - Generate the RGB profile.
  - Select a **Short push** or **Double push** button function to trigger the effect (see Section 4.3: *Add and Configure Buttons*).
  - Configure an automatic or custom-defined RGB/W profile.

### 5.5.1 Generating an RGB/W profile

You can create an RGB/W profile by following these steps:

1. Select Advanced features > Effect > RGB/W profiles (1).
2. Drag the RGB/W profile from the device tree into the Action Mapping box of a button. The new RGB/W profile is generated (2).

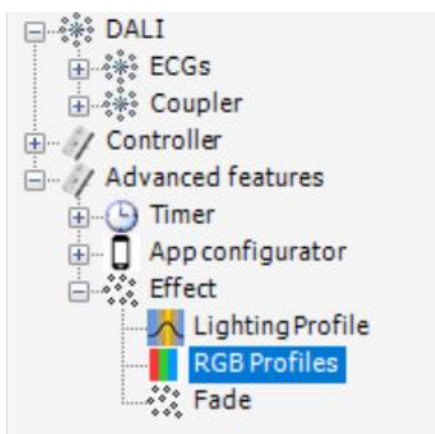

### 5.5.2 Selecting a button function for the RGB/W profile

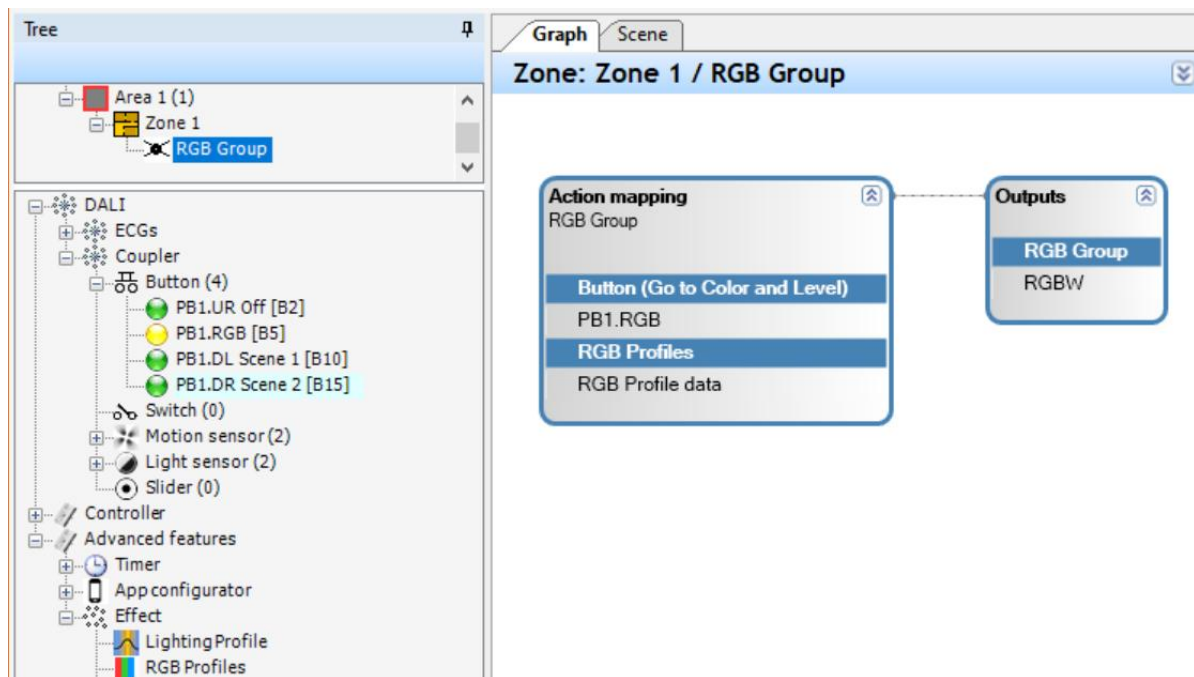

To use the RGB/W profile, it must be connected to a button function:

Select the button function (1) in the Action Mapping box and configure a button action for the RGB/W profile, e.g. Short Push > Start Effect (2).

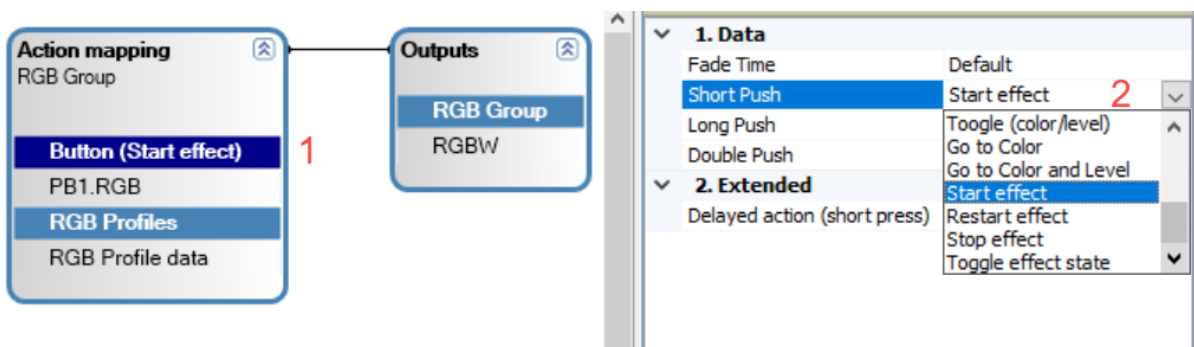

### 5.5.3 Configure an RGB/W profile

There are two modes available for configuring RGB/W profiles:

- **Auto Color Change Mode:**

Use this mode for quick setup when no specific color is required.

- **RGB/W Profile Mode:**

Use this mode to define a custom, individualized color change profile.

### 5.5.3.1 Configure Auto Color Change

The Auto Color Change mode uses a preconfigured automatic program to change color.

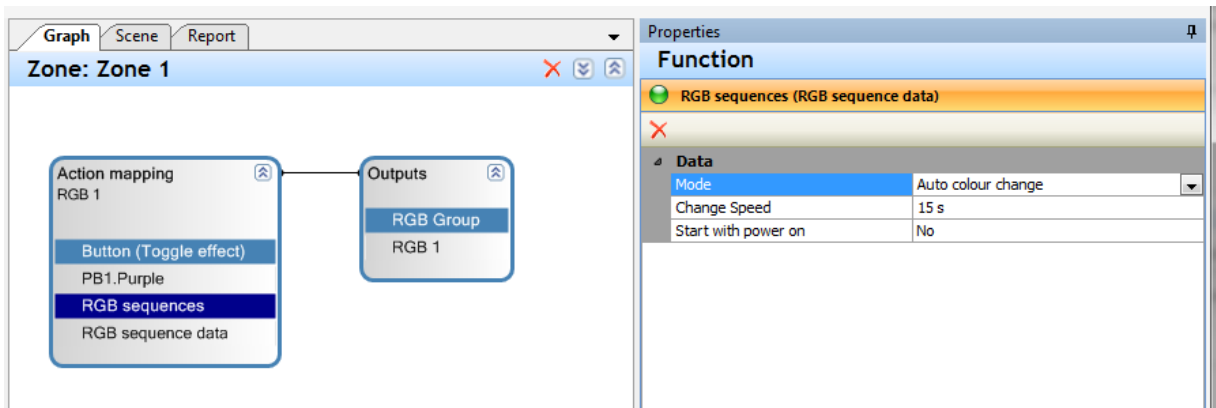

- Select the RGB/W profile (1) in the Action Mapping box.
- Select Auto Color Change Mode and adjust the required settings in the Properties window (2).

Option	Description	Parameters/Examples
Mode: Auto Color Change	Preconfigured automatic color change program	Auto Color Change
Change Speed	Time for one complete cycle through all colors.	50 s upwards
Start with power on	Automatically starts the sequence after a power cycle.	No Yes

### 5.5.3.2 Configure an individual RGB/W profile

The RGB/W profile mode allows you to define a sequence of colors.

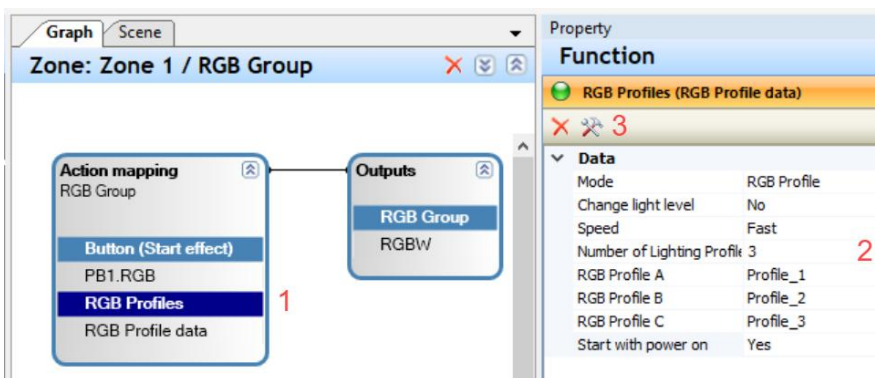

- Select the RGB/W profile (1) in the Action Mapping box.
- Select RGB/W profile mode and the required settings in the Properties window (2), see following table.
- Click Settings (3).
- Define a color profile by modifying the time/color settings (see next section).





Option	Description	Parameters/Examples
Mode: RGB profile	Individual color change program	RGB/W profiles
Change level	When activated, allows the brightness level to be adjusted for each color. When deactivated, the current light level remains unchanged during the color transition.	Yes No
Start with power on	Auto Start after power cycle	No Yes
RGB/W profile	Select RGB/W profile by name.	Profile name

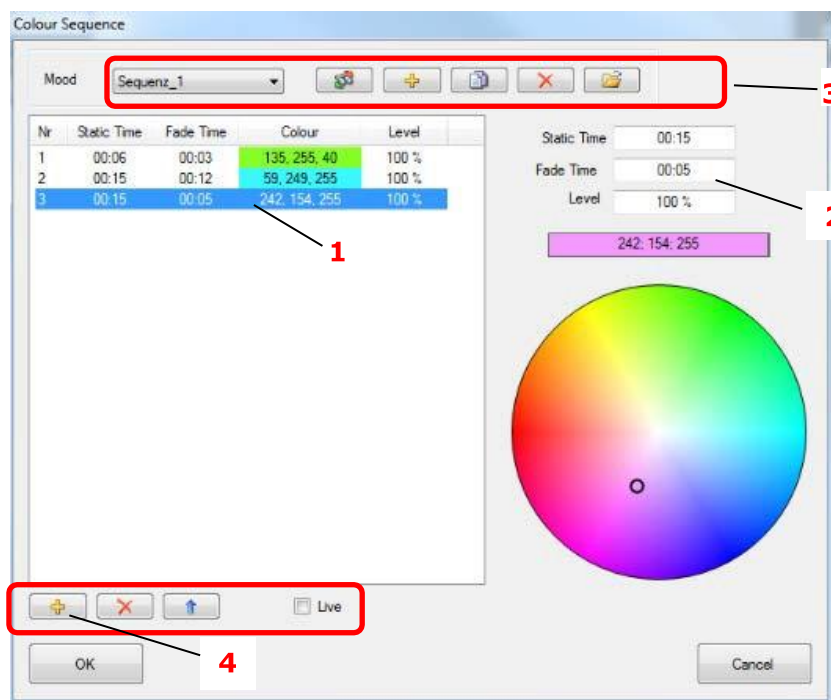





### 5.5.4 Defining color profiles

In the **Color Sequence** window, you can configure color profiles. Each profile consists of a list of time and color settings (1).



- To create a new profile, use the upper + button (3).
- To modify an entry in the profile, select it and edit the values in the configuration fields (2).
- To add a new entry to the profile, use the + button at the bottom (4).
- Make the necessary modifications to the profile. For a complete list of functions available in the window, refer to the following tables. Confirm by clicking OK.

Option	Description
Nr.	Number of time/color settings for this RGB/W profile, note that <b>Nr. 3</b> is marked in the image for further configuration.
	Add a time/color setting.
	Delete a time/color setting.
	Shift the selected time/color setting upward in the list.
	Shift the selected time/color setting downward in the list.
<input type="checkbox"/> Live	Option for real-time visualization of the RGB profile
Static Time	Displays the RGB/W values for the selected duration.
Fade Time	Gradually changes the RGB/W values over the selected duration.
Color	RGB/W color values
Level	Color level

Option	Description
	List of available RGB/W profiles
	Rename RGB/W profile.
	Add an RGB/W profile.
	Copy RGB/W profile.
	Delete RGB/W profile.
	Import RGB/W profiles from other DALI PRO project files

## 6 Tunable White

### 6.1 General

- Two different types of Tunable White devices are supported:
  - TW Group as combination of standard DALI devices with warm white and Cool white color temperature
  - TW device as DALI Device Type 8 TW device (DALI DT8 devices) There are therefore two ways to realize tunable white:

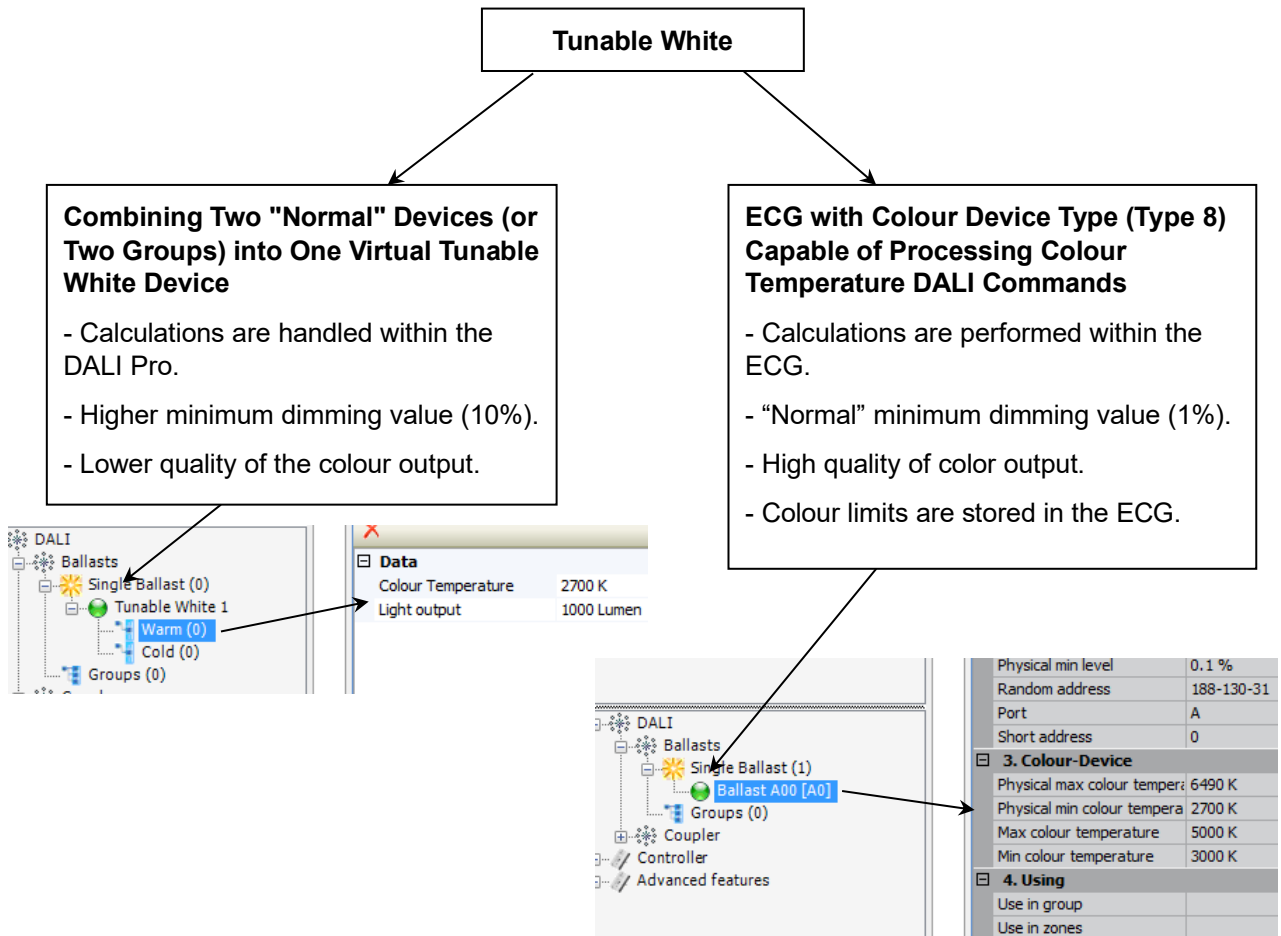

### 6.2 Adding a Tuneable White (TW) device and configuring basic settings

#### 6.2.1 Generating combined Tunable white lamps

##### 6.2.1.1 From the device tree

Generate a new TW device in the ECG section.



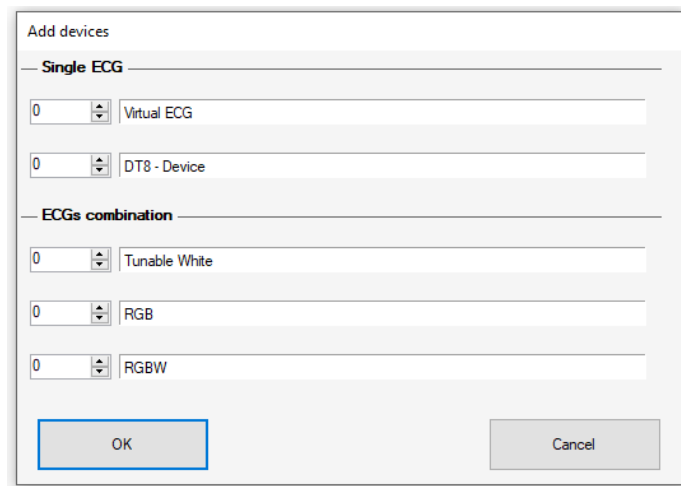
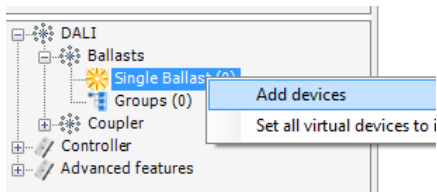

The ECG can be assigned to the warm or cool white group by drag and drop, or through the dialog accessed via the context menu. All not already used ECGs used in this group will be shown in the list.

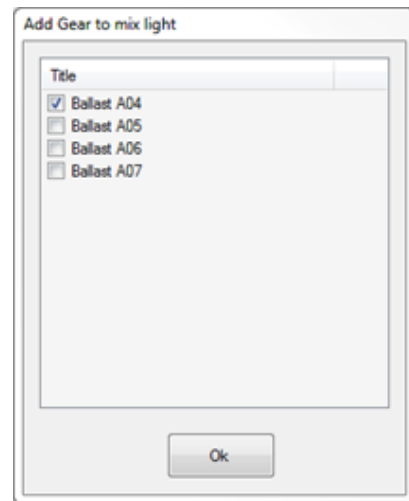
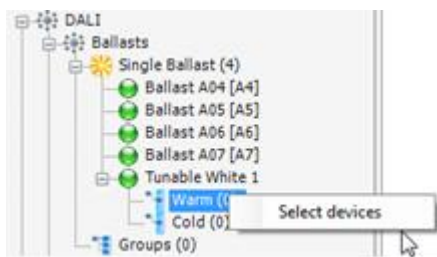

Devices can also be moved to the warm or cool group by drag and drop within the tree. When selecting the warm or cool group, the color temperature or intensity can be adjusted in the properties.

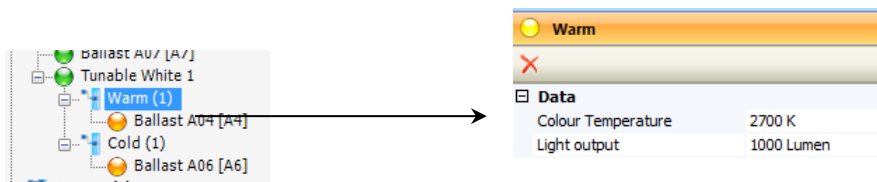

By using an LED driver, the linear dimming mode can be activated. This prevents changes in intensity during color level adjustments.

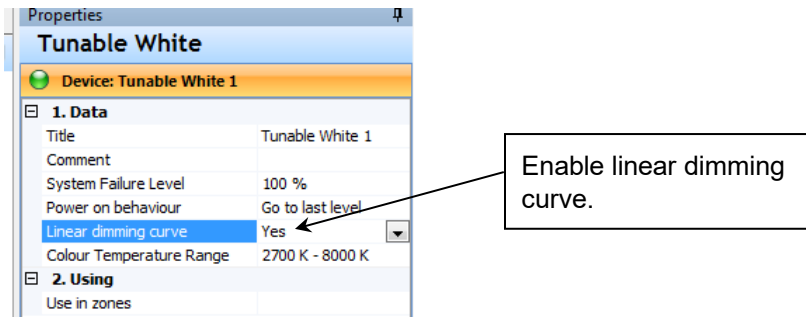

### 6.2.1.2 From the localisation dialog

Open the localisation dialog by the Icon in the tree. Use in the dialog the group functionality.

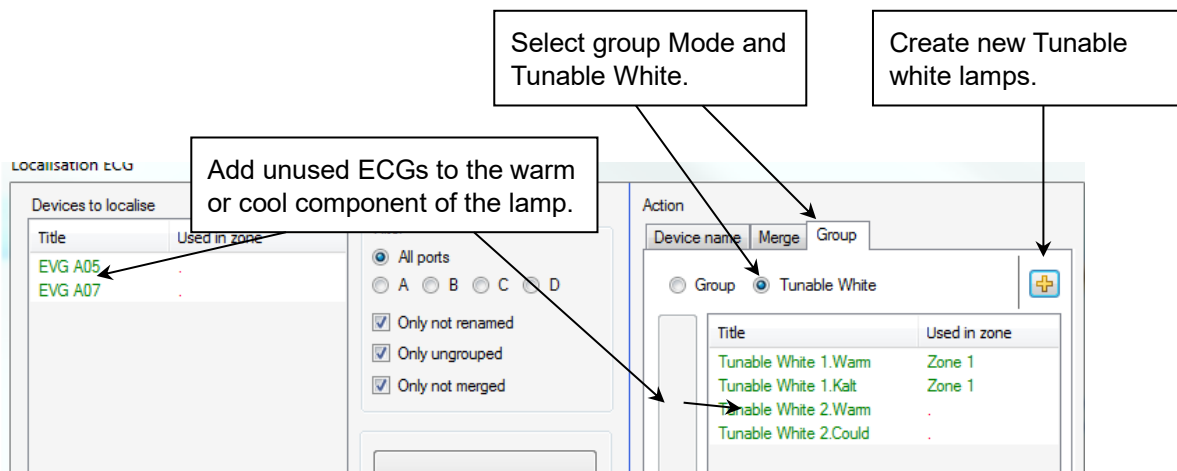

The actual ECG can be selected interactively by blinking and then added to the warm or cool component of the lamp.

### 6.2.2 DALI device type color (8-TW)

ECGs with device type 8 (DT8) that support the Tunable White subtype will be detected, and the color temperature limits will be displayed in the properties.



### 6.2.2.1 Configuring the color temperature limits for DALI DT8 devices

If needed, you can adjust the minimum and maximum color temperature values.

Note: The color temperature is stored in a different format in the device. The value will be adjusted to the nearest available color temperature supported by the device.

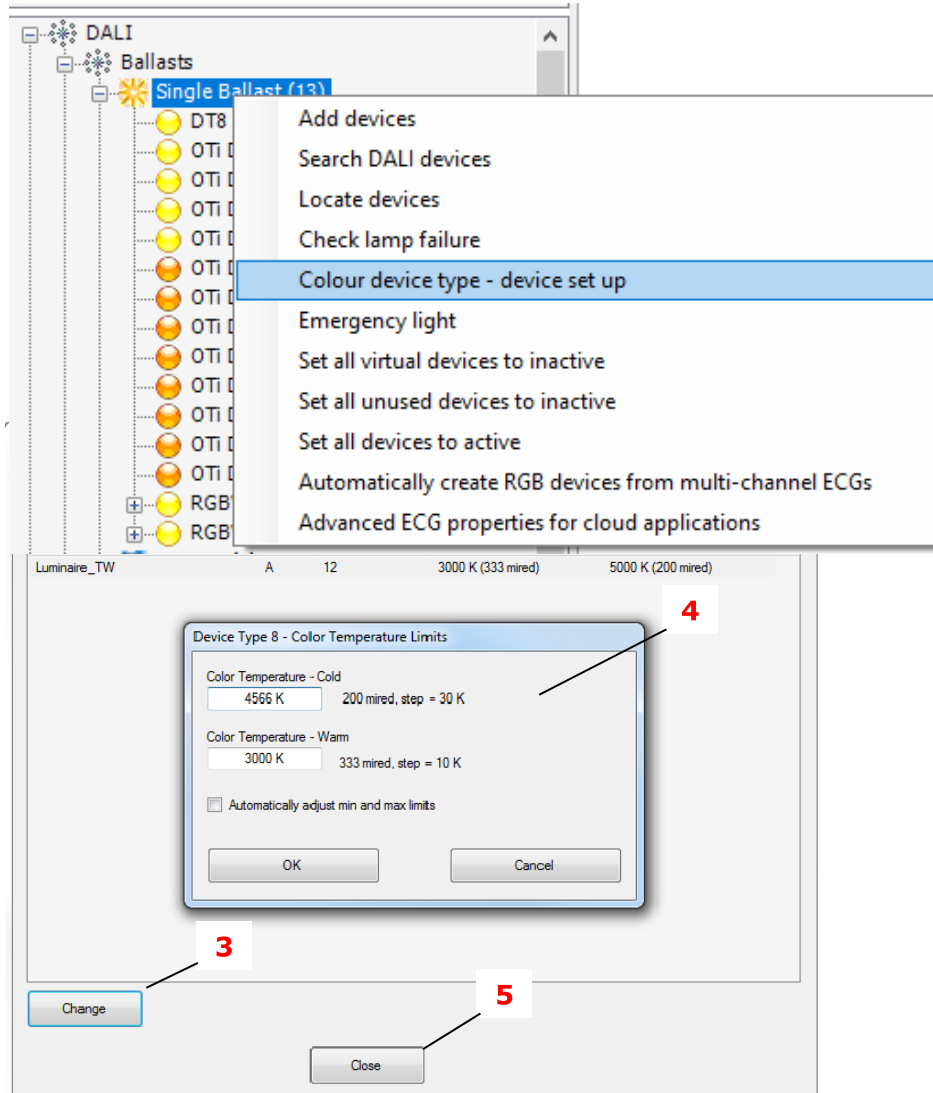

- Right-click and select ECGs > Single ECG > Color Device Type – Set Up (1). The Color Device Type – Set Up window will open, displaying a list of TW devices and their configured temperatures (2).
- Select a TW device in the list and click **Change** (3).
- Configure the temperatures in the window (4) and confirm with **OK**.
- Click **Close** (5) to exit the window.

### 6.2.2.2 Changing the color temperature and lumen output of a combined TW device

It is possible to set the color temperature of the connected warm and cool white device, as well as the lumen output.

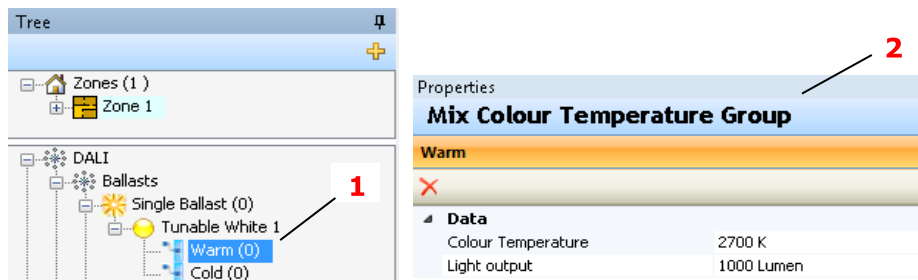

- Select the Warm or the Cool channel (1) for the TW device in the device tree.
- Select the required settings in the Properties window (2), see following table.

Option	Description	Parameters/Examples
Color Temperature	Set the color temperature (in Kelvin).	2700 K
Light output	Set the light output (in Lumen).	1000 Lumen

### 6.3 Configuring the TW device

To assign an input device to a TW device, add both devices to the Graph panel and configure the properties.

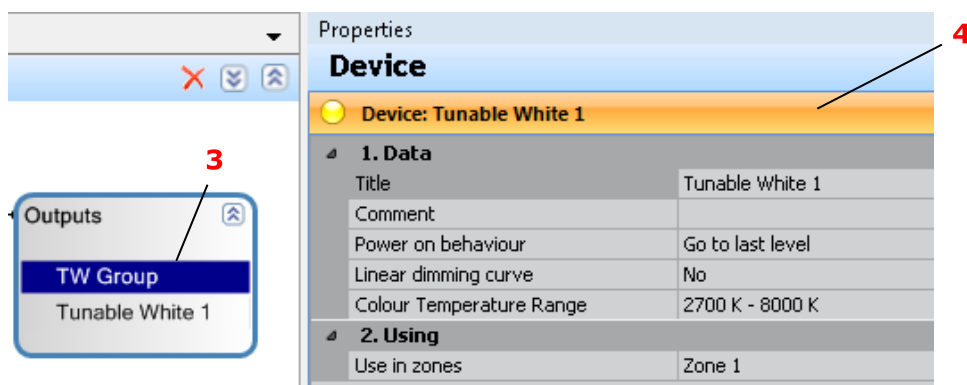
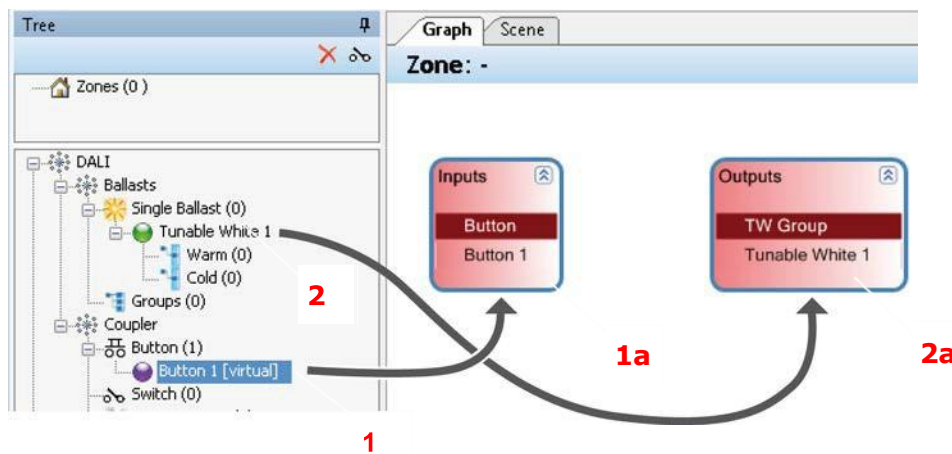

- Drag the button (1) from the device tree into the Graph panel (1a).
- Drag the TW device (2) from the device tree into the Graph panel (2a).
- Select the TW group (3).
- Configure the device in the Properties window (4).

### 6.3.1 Configuration settings

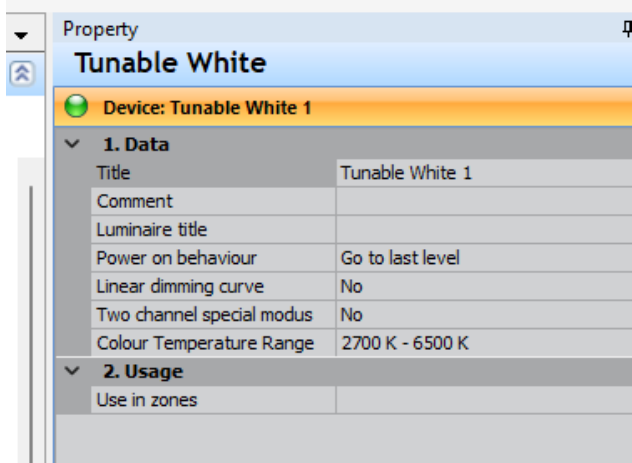

Option	Description	Parameters/Examples
Title	Rename the TW device.	e.g. Foyer
Comment	Add a comment for further information.	e.g. device located above luminaire
Power on behavior	Light on situation: <ul style="list-style-type: none"> <li>- Go to last level: Light on – with values from the situation before the power loss</li> <li>- Go to level: light level after power cycle</li> </ul>	Power On Level (0 – 100 %)
Linear dimming curve	Enabling this feature ensures the light level remains constant when adjusting the color temperature, optimized for TW settings.	No Yes
Color Temperature Range	Warm-Cool range for the TW device in Kelvin. See 5.2.2.2 <i>Changing the color temperature</i> , to configure these values.	2700 K - 8000 K
Use in zones	Lists the zones, where the TW device is used.	e.g. conference room

## 6.4 Add and configure buttons

Button actions are typically combined to make full use of available functionalities.

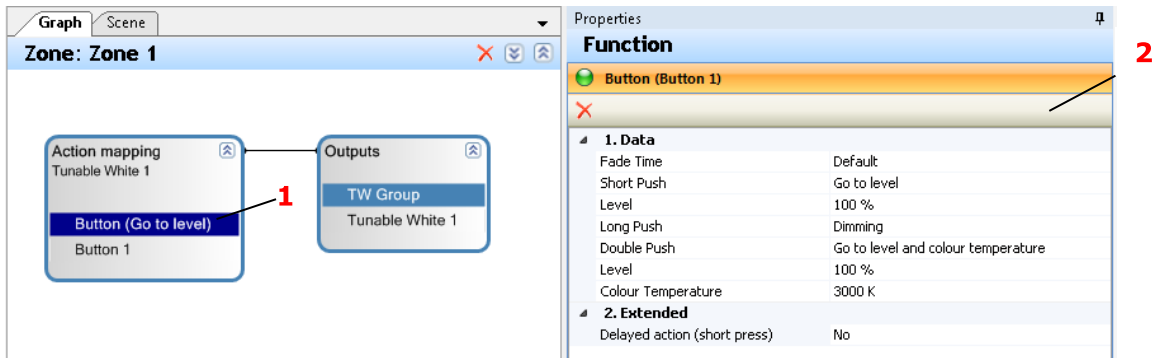

- In the Graph panel, connect the TW device (Inputs) to the button (Outputs): Click on Inputs and drag the mouse to Outputs. A connector line will appear, and the title "Inputs" will change to Action Mapping.
- Select a button function (1).
- Configure the button in the Properties window (2). Refer to the relevant description tables for more details.

### 6.4.1 General settings

Clicking on the Button element inside the Action Mapping window will display the following options in the Properties window:

Option	Description	Parameters/Examples
Fade Time	Duration to dim to the new brightness level.	Default (uses fade time stored from the ECGs) No fade 0.7 – 90.5 s
Short push	Select action for a short push of a button.	See 3.2.1.1 Short push actions
Long push	Select action for a long push of a button.	See 3.2.1.2 Long push actions
Double push	Select action for a double push of a button.	See 3.2.1.3 Double push actions
Level	Select the brightness level	0,1-100%
Color Temperature	Select the color temperature	2000K-10000K
Delayed action	Define up to two delayed actions for a Short push.If one or two actions will be configured, the additional properties for each action will be displayed (See the following tables).	No 1 2

### 6.4.2 Delayed action configuration options

Option	Description	Parameters/Examples
Time Delay	Step 1: Delay time until the first delayed action starts. Step 2: Delay time between the first and the second delayed action.	No 1 2
Fade Time	Duration to dim to the new brightness level.	Default, No fade, 0,7s- 90.5s
Action	Delayed action type: - Off - Go to level	Level (0,1 – 100 %)

### 6.4.3 Short Push actions

See chapter 3.2.1.1

### 6.4.4 Long Push actions

See chapter 3.2.1.2

### 6.4.5 Double Push actions

See chapter 3.2.1.3

### 6.4.6 Special function double light

When generating tunable white using two ECGs, it is possible to temporarily exit this mode and use both channels to achieve maximum light output.

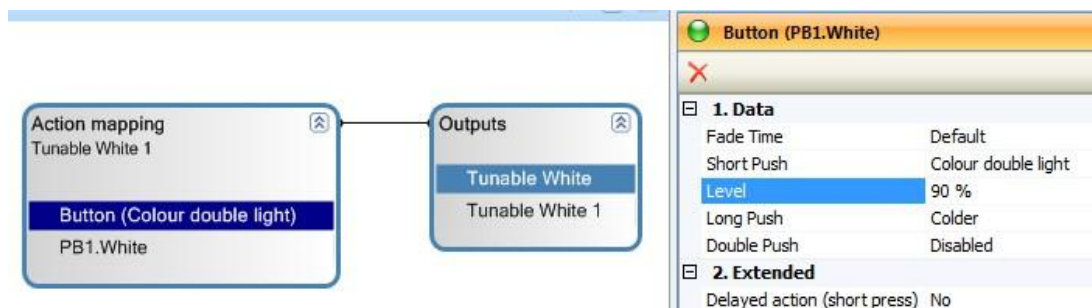

## 6.4.7 Configuring a button for multiple TW devices

To control multiple TW devices with one button, follow these steps in the **Graph** panel:

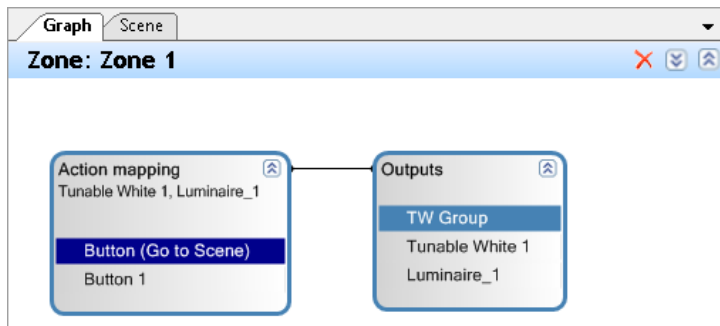

- Drag a TW device from the device tree into the **Graph** panel. A new (red) **Outputs** group will appear.
- Drag this new **Outputs** group into the **Action Mapping** box. The new TW device will now be merged with the existing **Outputs** group, and the configured Action Mapping will apply to all TW devices in the group.

**Note:** TW Groups and TW DT8 Devices cannot be combined in the same group. To control both TW Groups and TW DT8 devices with a single button, you must connect the button to each group individually by dragging the button into both groups.

If more TW devices should be controlled with one button, you can configure this in Graph panel.

## 6.5 Add and configure a TW scene

Light scenes are designed for scenarios where the ECGs in an **Outputs** group need to have different color temperatures and levels simultaneously. One button can be programmed to cycle through up to five different scenes (Short push > Go to next scene).

### 6.5.1 Adding a TW scene

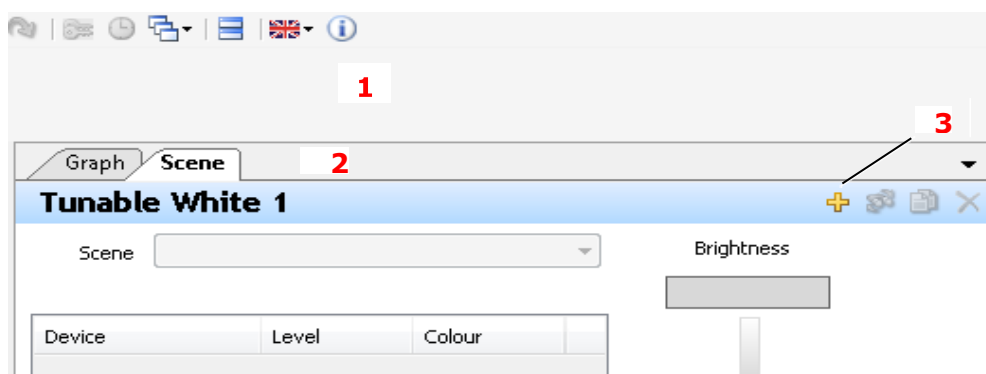

- In the **Graph** panel, select the desired **Action Mapping** box to choose the outputs that will be affected by the scene.
- Click the list (1) and switch to the **Scene** tab (2).
- Click + (3) to add a new scene.
- Rename the scene in the pop-up window



## 6.5.2 Configuring a TW scene

In the Scene panel, all devices affected by the scene are listed. Each device can have its own brightness and color temperature settings, or they can share the same configuration.

The screenshot shows the 'Scene' panel for 'Tunable White 1'. The table lists the device 'Tunable White 1' with a level of 100% and a color of 2700 K. The 'Property' panel shows the 'Function' for 'Device: Tunable White 1' with various settings like 'Title', 'Comment', 'Power on behaviour', etc. Red numbers 1 through 5 indicate the steps for configuring the scene.

- Select the required device (1).
- Set the color temperature (2).
- Set the brightness (3).
- If connected to the controller: Activate **Live** (4), to visualize the selection.
- Click **Go on** (5) after final selection to activate the configuration again.

## 7 Advanced features- Effect

An effect is a continuous process running in the background of the lighting control system that dynamically adjusts the lighting. It can influence various aspects of the light, such as brightness, color (RGB, RGBW), or color temperature (TW), creating smooth, ongoing changes.

### 7.1 Using an effect

To use an effect in a lighting group, follow these steps:

- In the 'Tree' device view, navigate to **Advanced Features > Effect**.
- Select the desired effect from the list.

In this example, we will use the 'Lighting Profile' data."

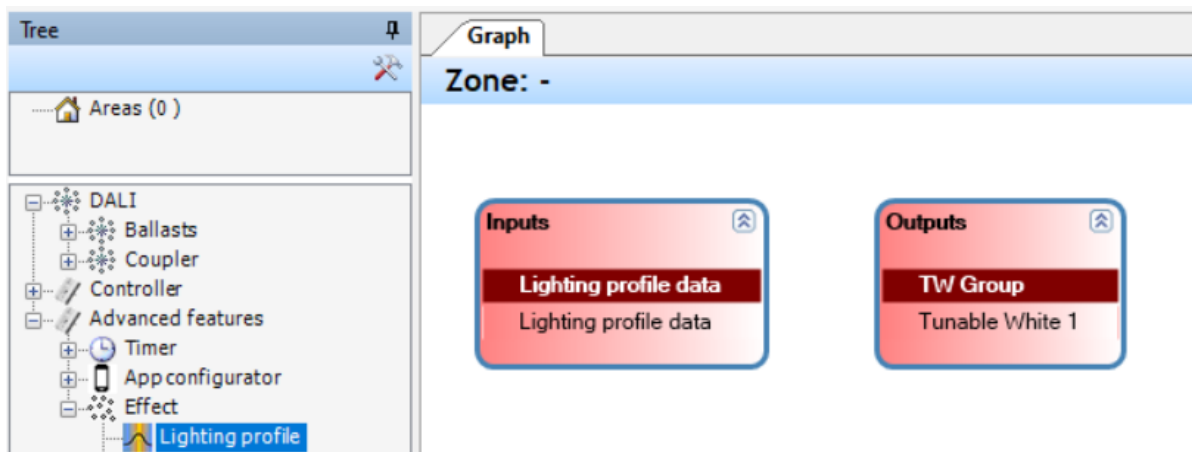

There are three ways to apply an effect in a lighting group:

1. **Drag into the "Graph Panel" and connect to the output:**
  - Drag the desired effect from the device view into the "Graph" function display.
  - Use the mouse to connect the effect to the corresponding "Output" (light group). This makes the effect available for the ECGs in this light group.
2. **Connect directly to an "Output":**
  - Drag the effect from the device view directly to the desired "Output." This automatically creates an "Action Mapping" function collection, connects it to the output, and makes the effect available for the ECGs in the light group.
3. **Drag "Action Mapping" into an existing function collection:**
  - If a function collection already exists, drag the effect from the device view into the appropriate function collection.

This integrates the effect with other actions in the collection, making it applicable to the lighting group.

## 7.2 Effect: "Lighting Profile"

A lighting profile, also known as daylight simulation, allows the control of brightness and/or color temperature over the course of the day, based on a set schedule, including sunrise and sunset times if applicable.

The profile consists of individually created steps—up to 80 steps for one day—that define the changes in lighting throughout the day.

- **With Simple ECGs:** The effect controls the brightness continuously while active. Activation requires a trigger such as a push-button, timer, or another switching function.
- **With Tunable White ECGs (1 x DT8) or Tunable White device combinations (2 x DT6):** The effect also controls the color temperature, in addition to brightness.

Optionally, brightness control can be enabled or disabled based on the configuration of the "Change Light Value" property, which has a "Change Level" setting (Yes/No).

### 7.3 Effect: RGB(W) Profiles

The **RGB(W) profile** effect controls colour changes in a predefined sequence. Depending on the configuration of the **"Change Light Level"** property (Yes/No), (1). brightness can also be adjusted simultaneously.

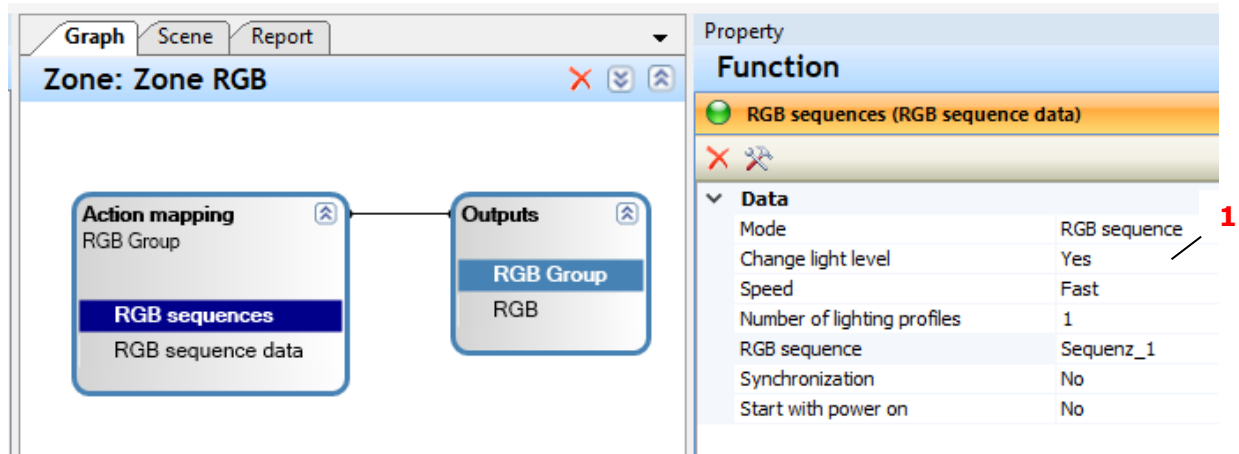

#### 7.3.1 Mode Configuration

Based on the mode settings (2), the effect can either perform a simple, continuous automatic colour change (**Auto colour change**) or follow a custom-configured **RGB Sequence**. The sequence can include up to 50 individual steps, each with specified colour transitions and hold times. These colour changes are repeated continuously until a stop command is issued.

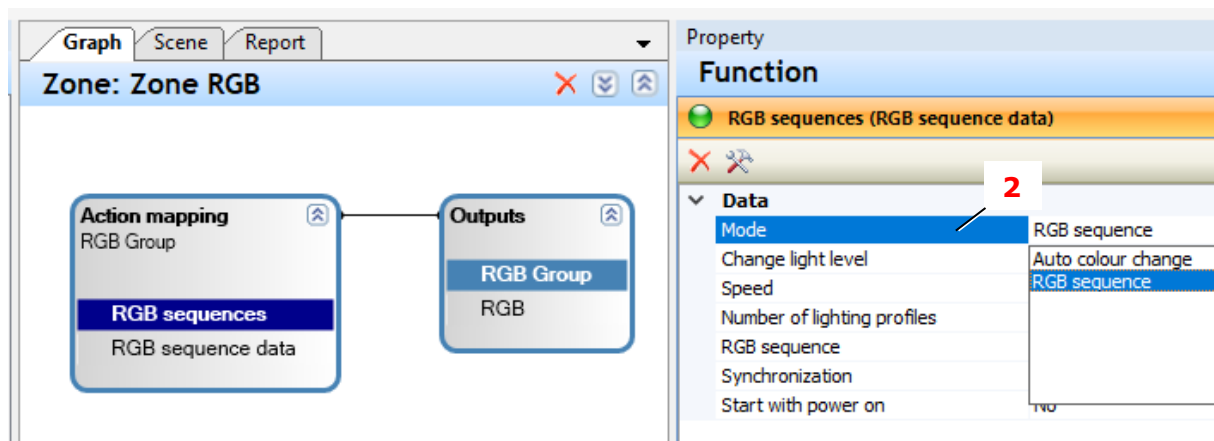

The RGB Sequence effect is compatible with **RGB** or **RGBW ECGs (DT8)** (Colour Device Type), as well as single or multi-channel drivers (3 x DT6) for **RGB** or (4 x DT6) **RGBW** device combinations

#### 7.3.2 Multiple effect profiles (for experienced users)

The **"Number of lighting profiles"** property (3) can be used to activate multiple sequences/profiles (4) in the effect, whereby only one profile can be active in the lighting group at any given time.

The screenshot shows the DALI Professional 3 software interface. The main window is titled 'Zone: Zone RGB / RGB Group'. It contains two main blocks: 'Action mapping' and 'Outputs'. The 'Action mapping' block is connected to the 'Outputs' block. The 'Action mapping' block has a sub-section for 'RGB sequences' with 'RGB sequence data'. The 'Outputs' block has a sub-section for 'RGB Group' with 'RGB'. The 'Property' panel on the right shows the configuration for 'Action mapping: RGB Group'. It includes a section for 'RGB sequences (RGB sequence data)' and a 'Data' table with the following settings:

Property	Value	Annotation
Mode	RGB sequence	
Change light level	Yes	3
Speed	Fast	3
Number of lighting profiles	3	
RGB sequence A \	Sequenz_1	
RGB sequence B	Sequenz_2	4
RGB sequence C	Holiday	5
Start with power on	No	6

Neutral designations such as "Light Profile A," "Light Profile B," "RGB Sequence A," "RGB Sequence B," etc., are used for the available sequences. During project planning, these assigned sequences can be freely named. (5)

This approach offers the advantage of allowing centralized changes to the assigned profile across all groups utilizing "RGB Sequence A." All references to the profile in other function blocks remain unchanged.

- Up to **15 different profiles** can be used for light profiles (TW).
- Up to **6 different profiles** can be used for RGB sequences.

### 7.3.3 Effect Control Functions

To utilize the effect functionality, it must be explicitly activated. Once started, the effect competes with manual lighting control functions. Depending on the type of effect, it will automatically stop when a manual lighting control function is activated.

To ensure the effect starts automatically upon controller restart, set the "**Start with Power On**" property to "Yes." (6).

If multiple profiles are configured for the effect, **Profile A** will be automatically activated when the controller is started.

Direct functions for push-button functions (as well as motion sensors, timers, switches, etc.), are (1):

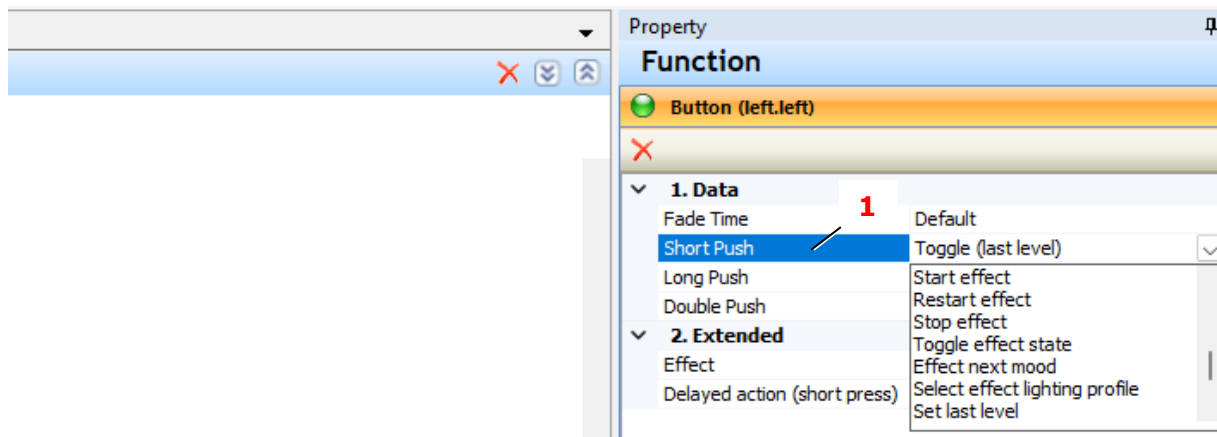

Function	Description
<b>Start effect</b>	<b>Starts the effect if not already active. If the effect does not control the light value (i.e., "Change light value" is set to "No"), the light will not be switched on automatically. If the effect does control the light, some steps may switch off the light.</b>
<b>Restart effect</b>	<b>Restarts the effect sequence from the first step, regardless of its current status. For a light profile, this has the same result as "Start effect." If the effect is time-based (e.g., determined by the position of the sun), it will play according to the defined schedule.</b>
<b>Stop effect</b>	<b>Stops the effect and keeps the light in its current state without any further changes from the effect.</b>
<b>Toggle effect state</b>	<b>Toggles the effect state: starts it if inactive, stops it if active. Use caution when toggling multiple times.</b>
<b>Effect next profile</b>	<b>Switches to the next profile in a multi-profile effect without changing its active or paused status.</b>
<b>Select effect lighting profile</b>	<b>Switches to a different lighting profile without affecting the effect's active or inactive status. If the effect is active and the light is on, the change is immediately visible. If the effect is inactive or the light is off, the profile change will take effect the next time the effect or light is activated. (Available from firmware versions: DALI PRO CON 4 RTC from FW 3.83 and DALI PRO 2 IoT from FW 3.1.15.x).</b>

With push-button functions (as well as motion sensors, timers, switches, etc.), it's important to distinguish between two types of functions:

- 1. Functions Directly Related to the Effect (1):** These functions specifically control the effect itself.
- 2. Extended Functions (2):** These functions can also influence the effect indirectly.

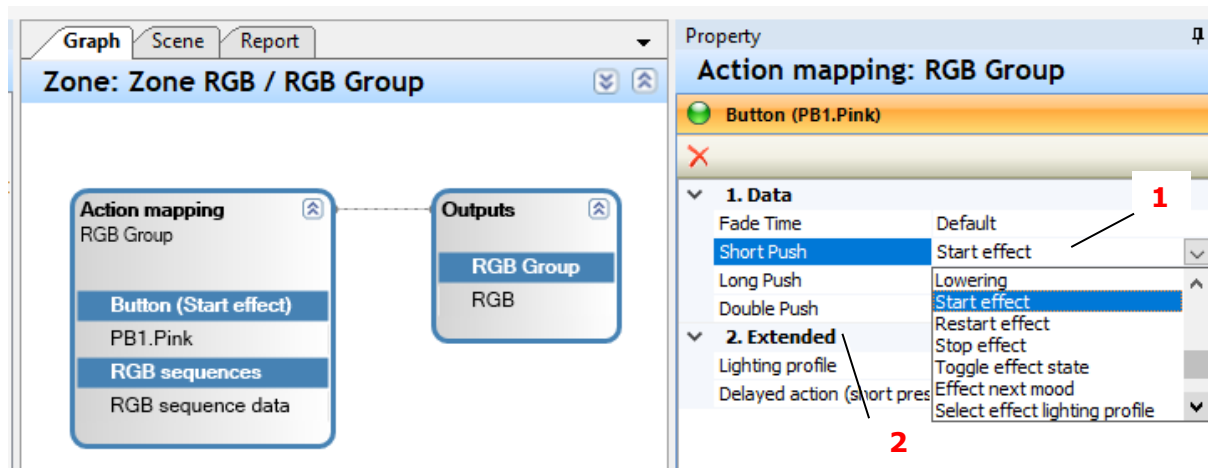

With a single button, it is possible to configure the effect functions as a **short push** or **double push**. The short and double push can each be assigned different functions. (1)

If multiple profiles are available for an effect, you can choose the desired profile when activating the effect through the "Lighting profile" property (2). This selection applies to both short and double pushes of the push-button.

For general light control functions like switching lights on/off or adjusting brightness, additional **"Extended"** settings allow you to manage the effect. You can configure whether the effect should be activated **"Enable"**, deactivated **"Disable"** or remain unchanged **"No change"** when using light control functions. (3)

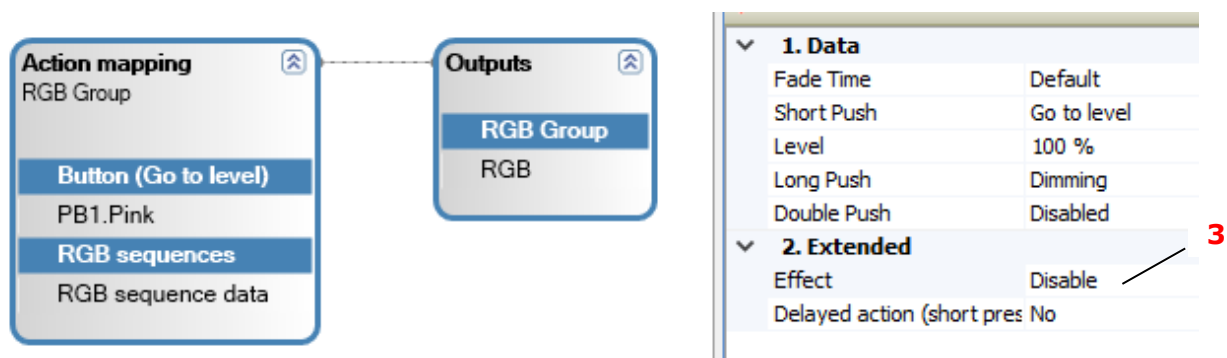

If the effect is allowed to change the light value and a light control function is active, the selected value (e.g. 80%) is immediately applied to the current light value of the effect.

It is important to note that the light value of the effect can also be 0%. It is therefore possible for the light to remain switched off after the action has been carried out.

If the effect is allowed to change the light value and the light is switched off via other functions, the effect is stopped in any case and the set value for the effect is ignored. This means that regardless of the settings, the effect is always stopped when the light is switched off.

A time event or a time switch can be used, for example, to automatically change the profile throughout the day. The "Change effect" function is used to set the currently valid profile.

In addition to its main function of switching the light on to a specific light value, a motion sensor can also be configured to activate the effect.

This means that the motion sensor is only responsible for switching on the light and starting the effect, while the timer only selects the currently valid profile.

## 7.4 Lighting Profile: Daylight simulation

Daylight simulation allows for the replication of the natural progression of daylight through a timetable that specifies color temperatures and light values for various times of the day, including sunrise and sunset. Additionally, it is possible to create entirely different lighting scenarios that do not adhere to the natural daylight cycle.

### 7.4.1 Configure a daylight simulation

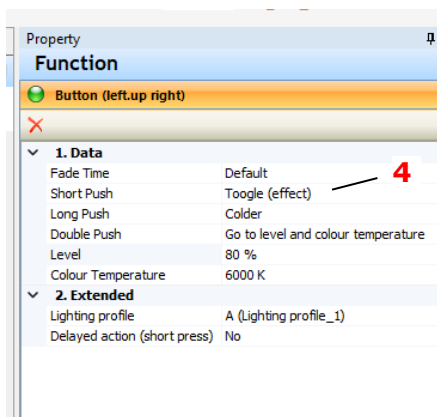

- Drag the **Daylight simulation** from the device tree to an Action Mapping box in the Graph panel.
- Edit the **Daylight simulation (1)** in the Properties window: Set the daylight simulation sequence (2). For all properties, see the following table.
- Change the **Short push** function to Toggle (Effect) (4)
- To define a constant light level, activate the **Level** property. Define the light level (in percent). This configuration changes the predefined light levels in the daylight simulation sequence.

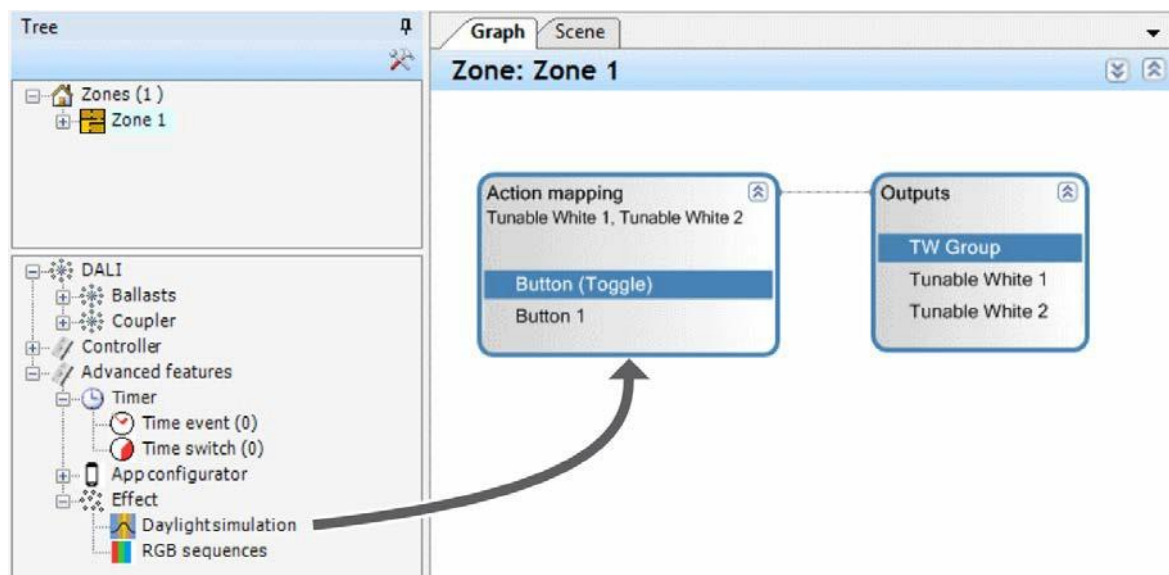

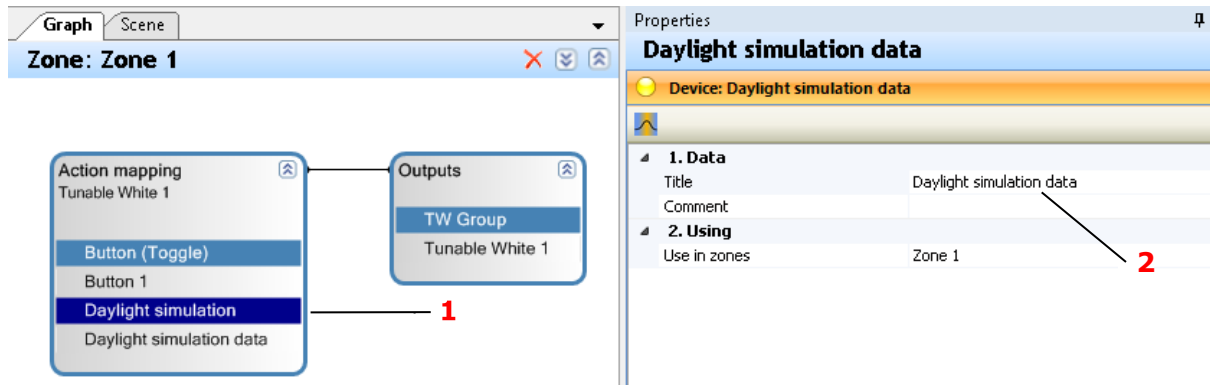

The following data can be set for Daylight simulations:

Data	Description
Title	Name of the daylight simulation sequence
Comment	Add a comment for further information, e.g. Simulates a summer day in auditorium
Use in zones	List zones where the daylight simulation is used.

### 7.4.2 The lighting profile editor

The lighting profile editor can be opened via the context menu of the device view. Alternatively, the editor can also be opened via the icon (1) in the properties of the effect.

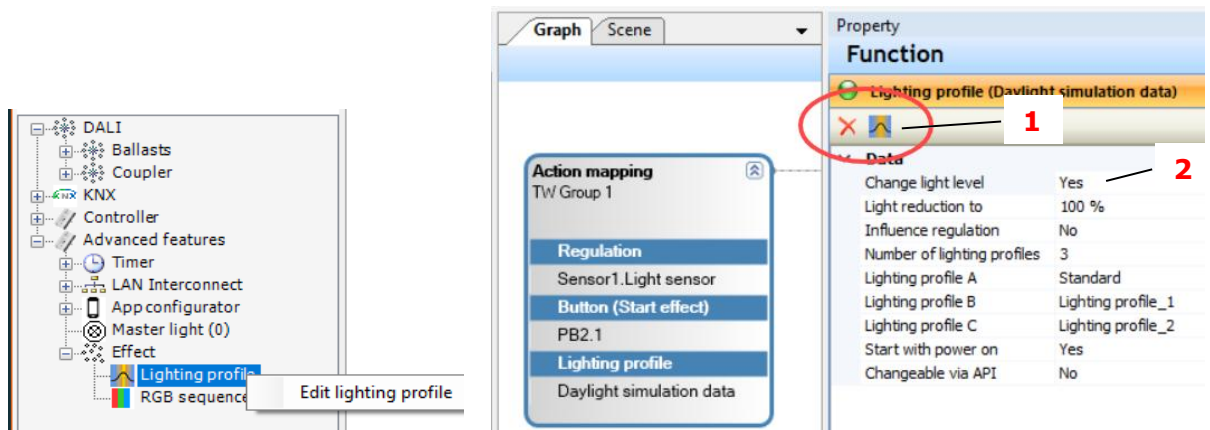

If the **"Change light level"** (2) property is set to "No", only the color temperature values are displayed in the Editor. The extended light value functions such as control and sunlight sequences are only displayed if they are configured accordingly in the function collection.



### 7.4.3 Configuring and Managing lighting profiles

Existing lighting profiles can be edited, copied, imported or new profiles created in the editor dialog. The icons in the upper area are used to manage the profiles.

- To **create** a new lighting profile, click on the + icon (1). This adds a new lighting profile, e.g. "**Lighting profile\_2**". The automatically generated name of the new lighting profile can be changed (2).
- You can create a **copy** of the currently selected light profile (3) or delete it using the X icon (4).
- It is also possible to **import** light profiles from another project into the current project (5). Once you have selected a project file, you can select the light profiles to be imported.

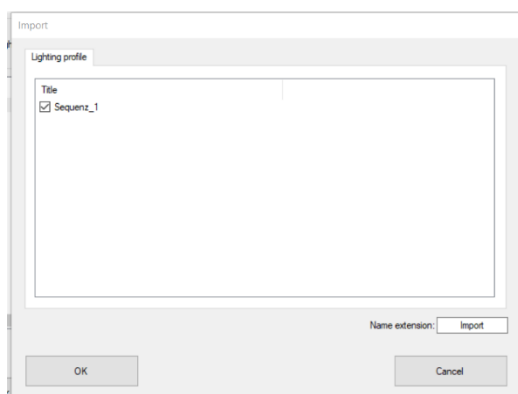
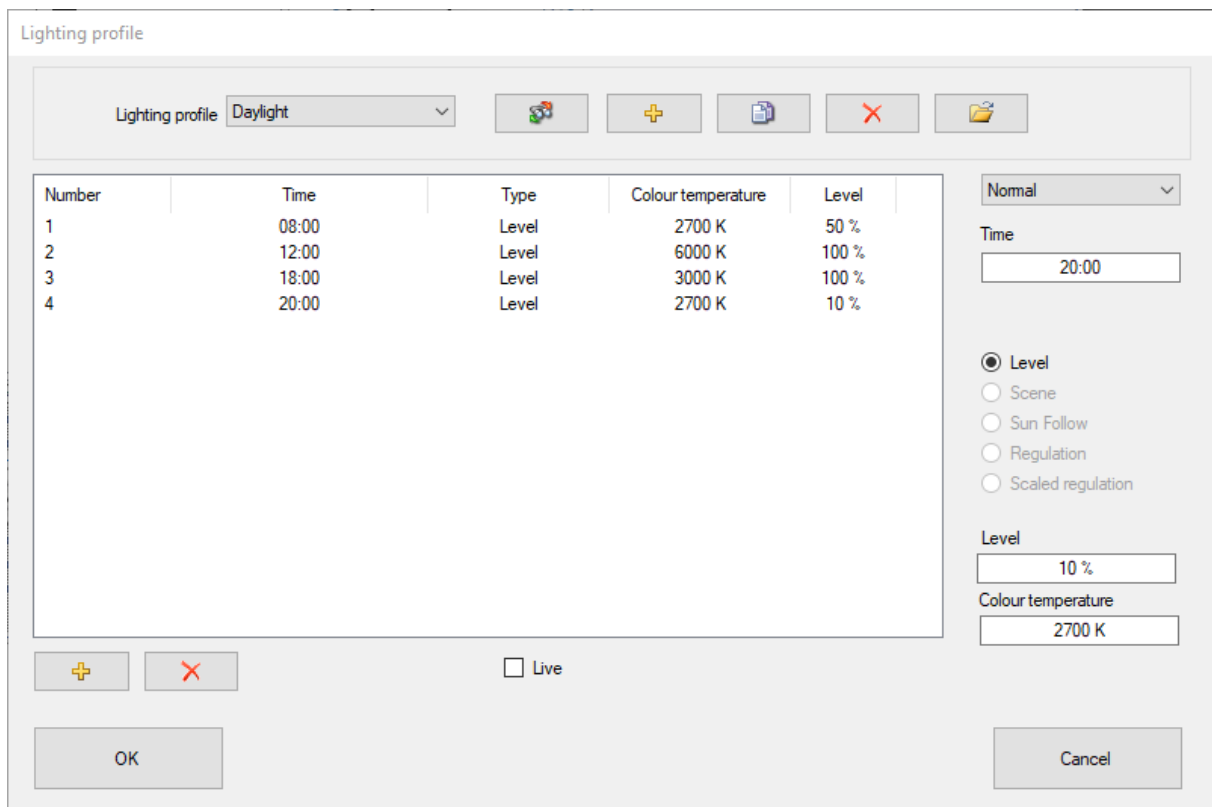

A light profile is primarily defined by steps that set specific light values and color temperatures at designated times. The intermediate values are calculated using linear interpolation.

- To add a new intermediate step to the light profile, use the + icon (6) and to delete a selected step, use the X icon (7).

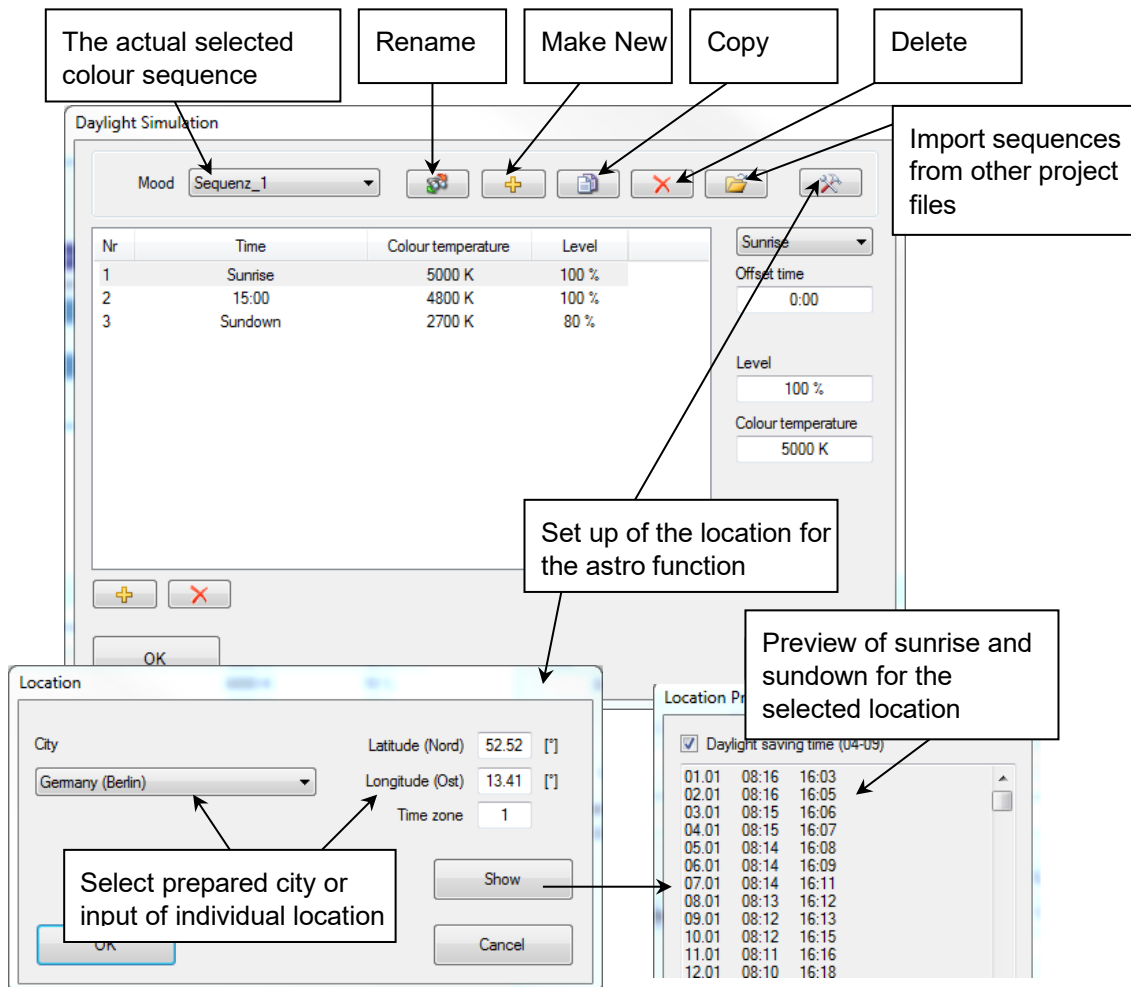
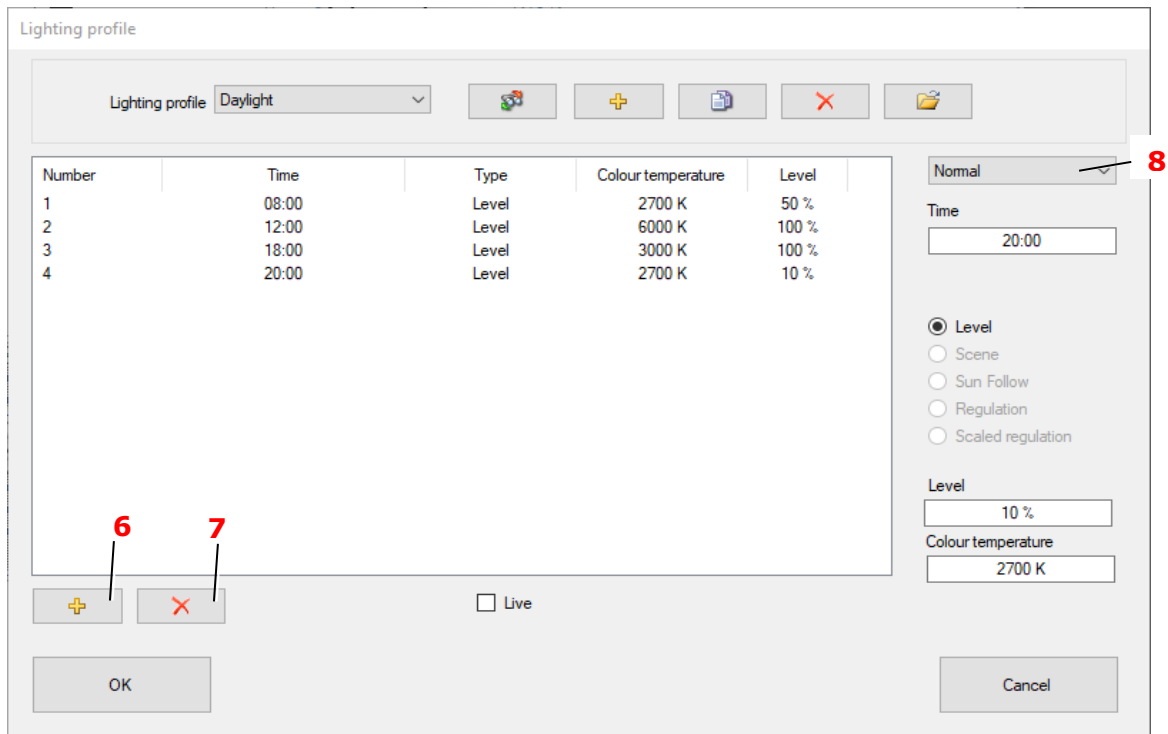

The time for the selected step can be set in area (8). You can either specify an absolute time **"Normal"** or use a time relative to sunrise **"Sunrise"** or sunset **"Sunset"** (9).

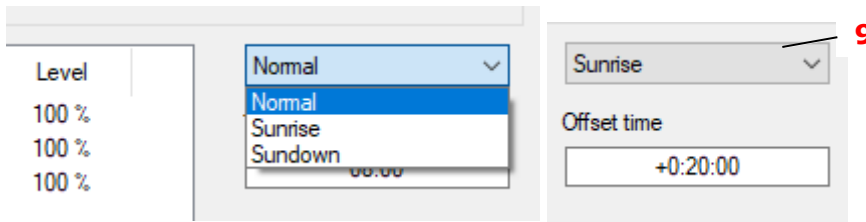

Steps before or after a sunrise or sunset entry can be optionally restricted to a specific time range. In the example, the step is set to occur 20 minutes after sunrise (SA +20min) but never before 7:00 AM.

Number	Time	Type	Colour temperature	Level
1	(07:00)	Only limit		
2	Sunrise +00:20:00	Level	3000 K	100 %
3	12:00	Level	6000 K	100 %
4	18:00	Level	3000 K	100 %

Normal

Time: 07:00

Only limit

There are several options for defining the light value for each created step: At what time should which light value or light color be achieved, and through which action?

Normal

Time: 08:00

Level  
 Scene  
 Sun Follow  
 Regulation  
 Scaled regulation

Level: 50 %

Colour temperature: 2700 K

Function	Description
Level	A specific light value (e.g. 50%) and a color temperature (e.g. 2700K) can be entered here.
Scene	A DALI light scene can be activated and maintained until the next step. This option is only available if light scenes have been pre-configured.
Sun Follow	From this step to the next, the brightness is controlled by the "Follow sunlight" function. The light level increases as the brightness detected by the sensor increases.
Regulation	From this step to the next, the brightness is determined by the control function.
Scaled regulation	Similar to regulation, but with reduced brightness compared to normal control. This can be adjusted directly in the editor.

#### 7.4.4 Starting and Stopping Daylight Simulation

The daylight simulation effect runs continuously in the background, adjusting light properties over time. There are two general behaviors depending on whether the light value should be adjusted:

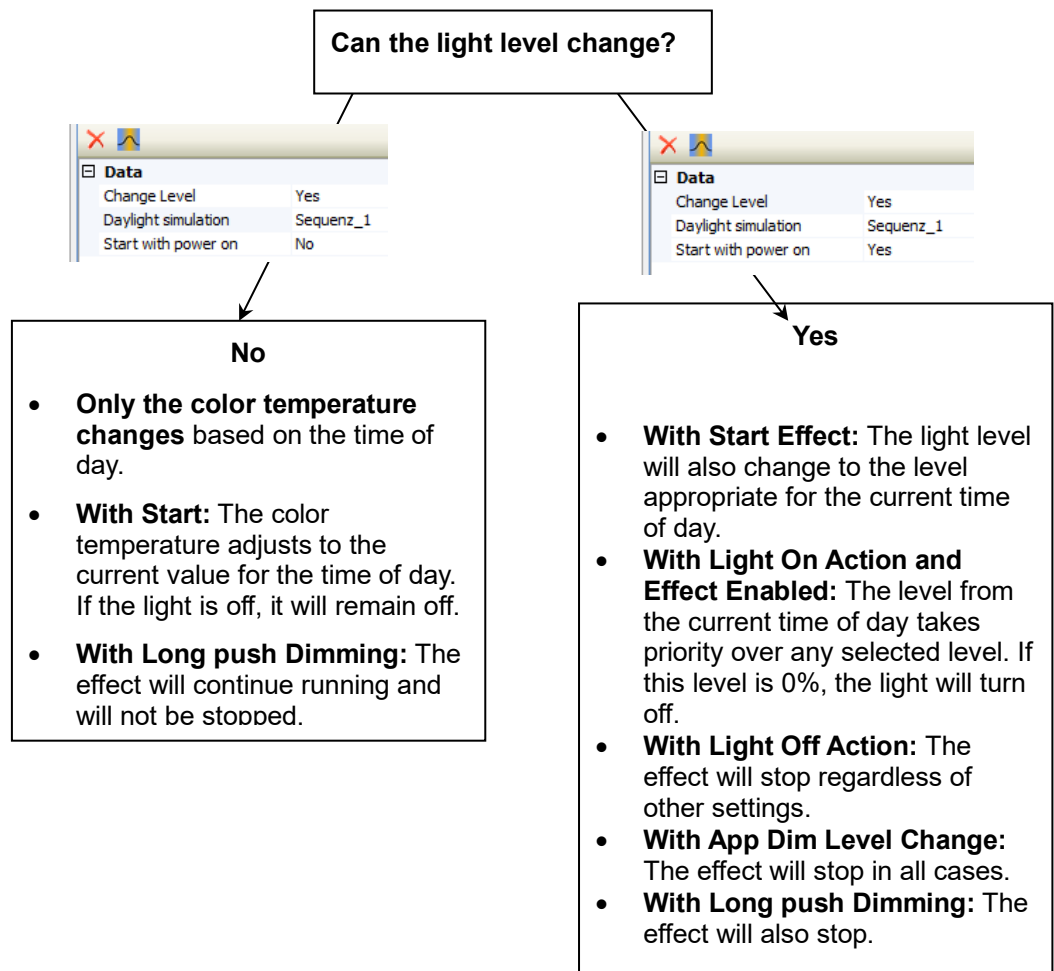

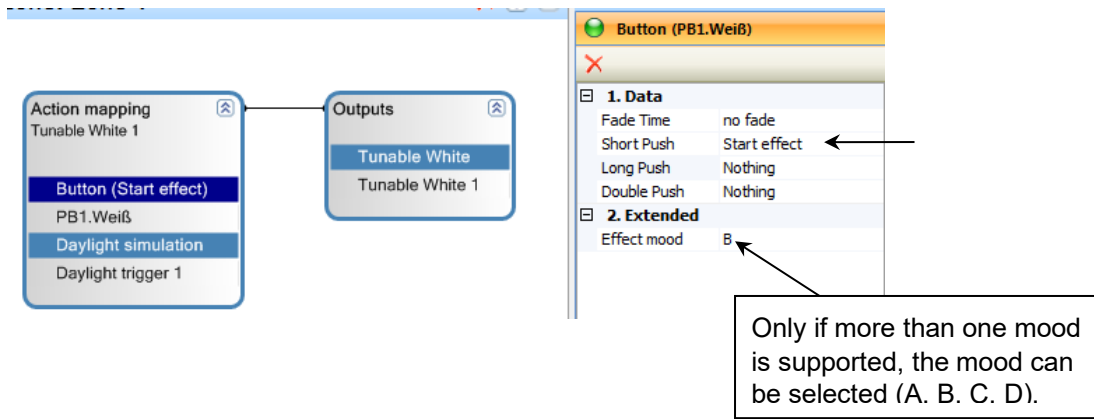

If the daylight simulation effect only changes the color temperature, the effect can be started (enabled), stopped (disabled), or left unchanged with each light activation. However, the detailed behavior depends on the property "Can the effect change the light."

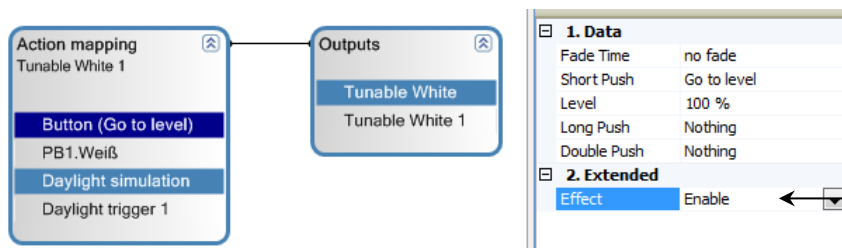

#### 7.4.4.1 Example: Doctor's Office

During the day, the daylight simulation should run, adjusting both the light level and color temperature. The setup includes three buttons:

**PB1.White:** Light on with daylight simulation running, adjusting color temperature and brightness according to the time of day.

**PB1.Orange:** Fixed color temperature and light level suitable for doctor's work.

**PB1.Purple:** Light off.

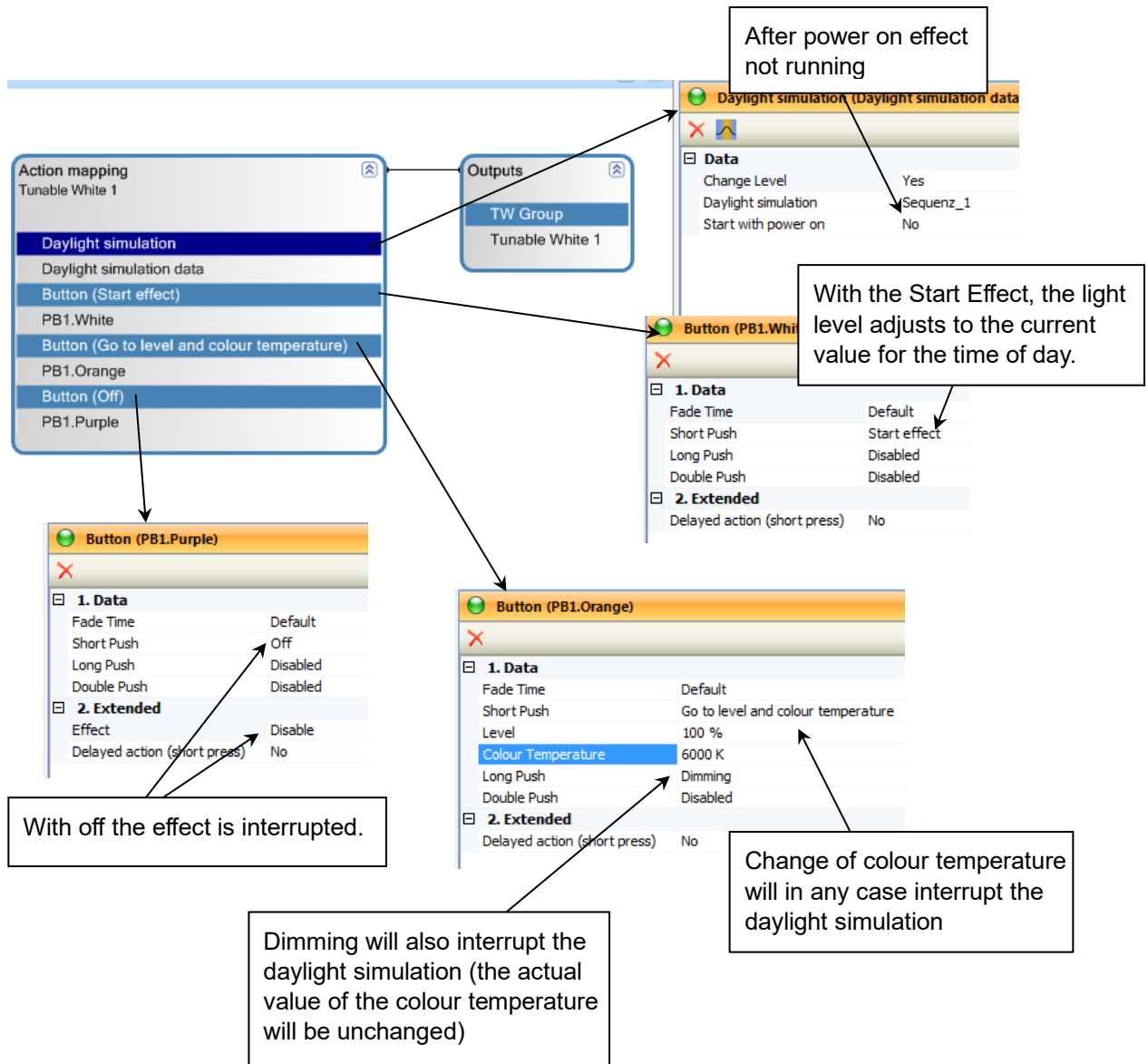

#### 7.4.4.2 General Reduction of the Light Value (from 3.1.16.22122 & µCFW 1.06.18)

If, during operation, it is determined that the light profile generally requires too much brightness, the operator wishes to permanently lower the brightness, or additional artificial lighting has been installed as a precaution, the light reduction function can be set to "Light reduction to" (1).

Note that this reduction has a permanent effect, regardless of the selected profile, and acts as a scaling factor across the entire light range. For example, if you set the reduction to 80%, the light value will be multiplied by 0.8, reducing the brightness accordingly:

Light Value	Reduction	x Factor	New Light Value Description
60%	80%	x 0.8	48%
80%	100%	x 1	80%

The Influence Control (2) function is set to "No" by default and is required for special fixed profiles. Only activate this function if you are certain, it is necessary.

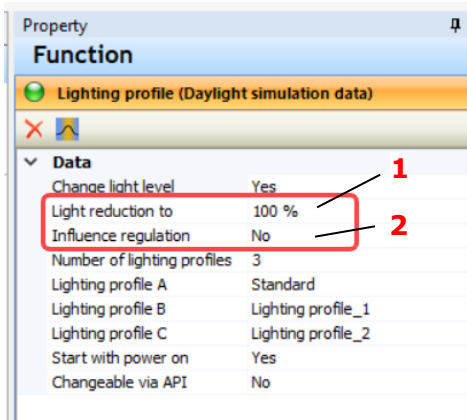

## 7.5 Lighting Profile: RGB Sequence

An RGB(W) sequence consists of a series of brightness and color values, with each step having a defined hold time and a fade time to transition to the next step. After the last step, the sequence fades back to the first step to create an endless cycle. A sequence can include up to 50 individual steps.

### 7.5.1 The RGB sequence editor

The RGB sequence editor can be accessed either via the context menu in the device view or by clicking the icon (1) in the effect properties. To open the editor, ensure that the **"RGB sequence"** mode is selected.

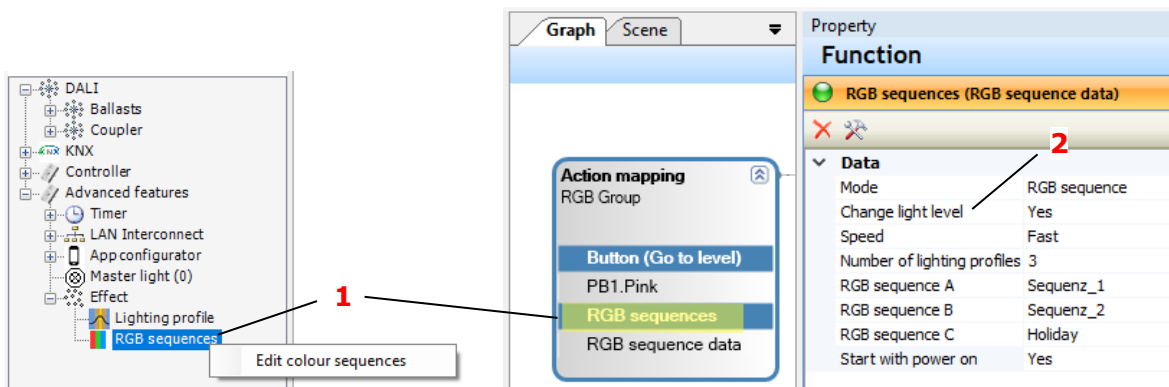

If the **"Change light level"** (2) property is set to **No**, only the color temperature values will be shown in the editor.

## 7.5.2 Configuring and Managing RGB(W) Sequences

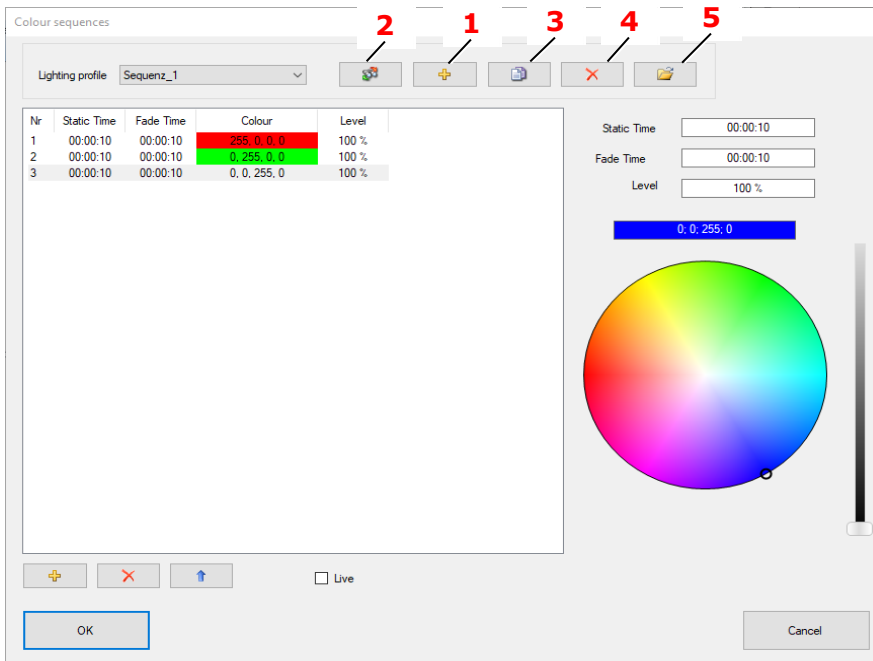

In the editor dialog, existing RGB sequences can be edited, copied, imported, or new sequences created.

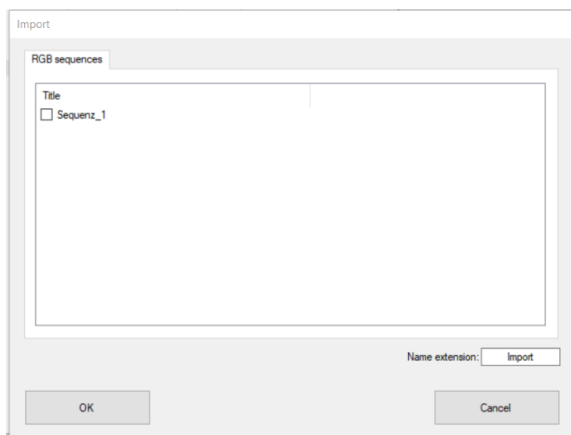

The icons in the upper area are used to manage the RGB(W) sequences.

- To create a new sequence, click on the + icon (1). This adds a new sequence, e.g. "sequence\_2". The automatically generated name of the new sequence can be changed (2).
- You can create a **copy** of the currently selected color sequence (3) or delete it using the X icon (4).
- It is also possible to **import** color sequences from another project into the current project (5). Once you have selected a project file,

you can select the sequences to be imported. This allows you to reuse sequences from other projects and use them in your current project.



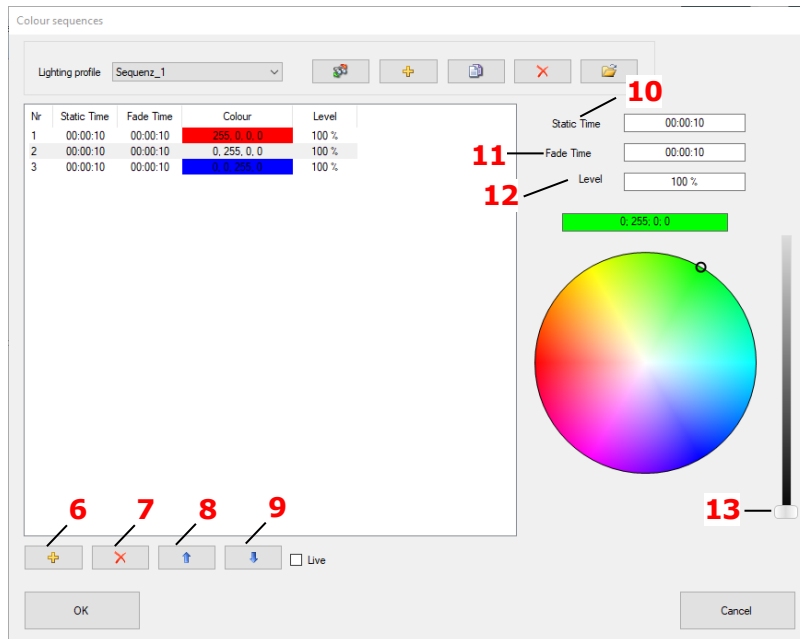

- To **add a new step** to the sequence, click the **+** icon (6). You can then define parameters such as brightness, color values, hold time, and fade time for the new step.
- Use the **X** icon (7) to **remove** the currently selected step. The remaining steps will automatically adjust their order.
- The **Up** (8) and **Down** (9) icons allow you to change the position of a selected step in the sequence.
- In the right-hand area, set the **Static Time** (10) for the step, defining how long it holds the specified brightness and color values.
- Set the **Fade Time** (11) to smoothly transition to the next step, with the color space between steps interpolated smoothly.
- If changing the light value is activated, you can specify individual brightness levels "**Level**" (12) for each step, including the option to use 0% brightness.
- For RGBW sequences, a **white component slider** (13) appears along with the RGB controls. Adjust the white proportion by moving the slider. Up to the halfway point, white is mixed in equally with RGB. Beyond that, the white component dominates, reducing the RGB influence. At **100% white**, the color component is reduced to **0%**.

## 7.6 Fade

The "**Fade**" effect is a one-time, gradual change in brightness over a duration ranging from 30 seconds to 6 hours. When initiated, the brightness begins to adjust from the current light value, and the effect automatically stops once the final light value is reached. If the current light value matches the target light value, the effect will stop immediately.

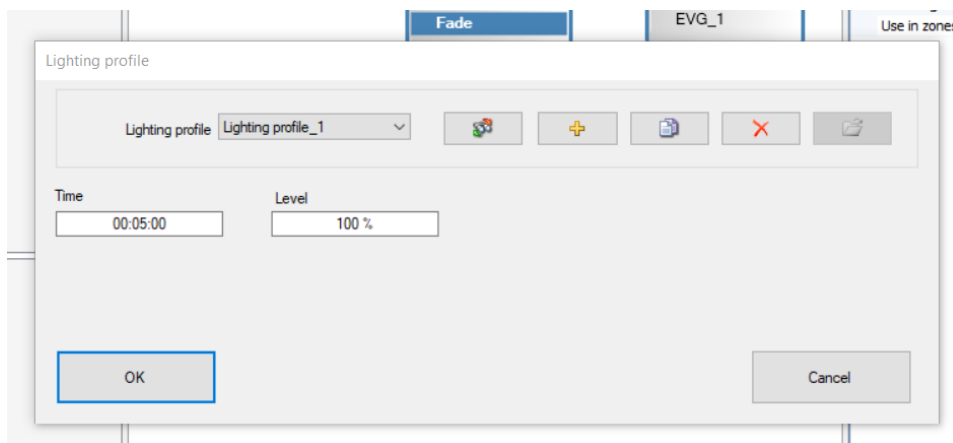
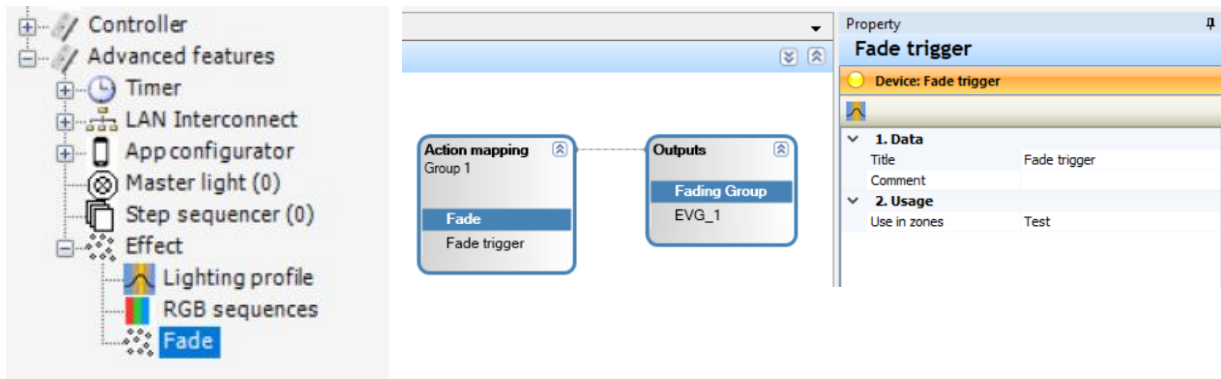

## 8 Advanced Features- Timer

Time event functions allow you to set the specific time and day of the week when an action should be executed.

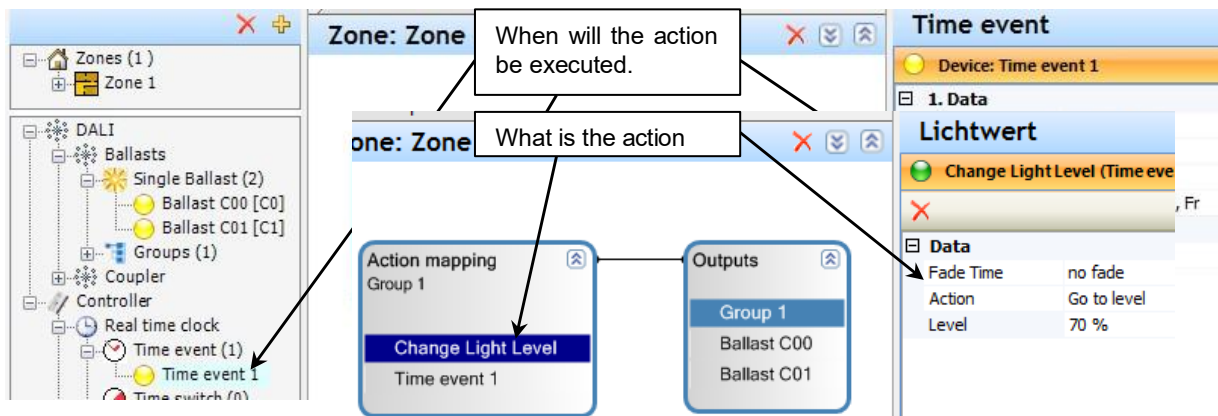

Multiple time events can be combined to trigger the same action at different times during the day or on different days of the week, providing flexible scheduling options.

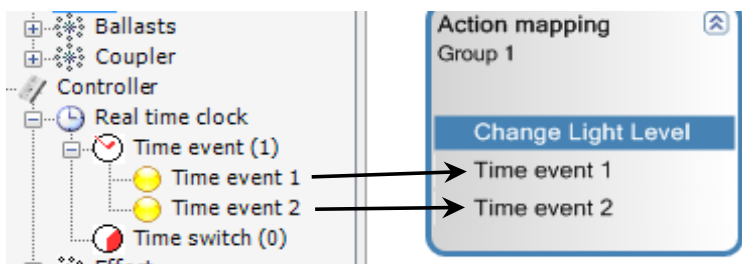

### 8.1.1 Time Switch

A time switch operates like a standard switch with two states: *On* and *Off*.

- For each day, you can configure up to one *On* switch time and one *Off* switch time.
- This setup enables the switch to be active only on selected days of the week, or to remain in the *On* state for a duration longer than one day.

The screenshot displays the configuration interface for a time switch. Key components include:

- Switchpoints overview:** A window showing a weekly schedule of switch points.
 

Day	Time	State
Mo	08:00	On
Mo	18:00	Off
We	08:00	On
We	18:00	Off
Th	08:00	On
Th	18:00	Off
Fr	08:00	On
Fr	18:00	Off
- Time switch Properties:** A panel for 'Time switch 1' with the following settings:
  - 1. Data:** Title: Time switch 1, Comment: (empty)
  - 2. Switch On:** Time: 08:00, Week days: Mo, We, Th, Fr
  - 3. Switch Off:** Time: 18:00, Week days: Mo, We, Th, Fr
  - 4. Using:** Use in zones: Zone 1
- Function: Switch (Time switch 1):** A panel showing the actions for the switch:
  - 2. Switch On:** Action: Go to level, Level: 100 %
  - 3. Switch Off:** Action: Off

Callouts in the image provide additional context:

- 'Show overview for all switch points in the week.' points to the 'Switchpoints overview' window.
- 'Action for switch on event.' points to the 'Switch' button in the 'Action mapping' panel.
- 'Action for switch off event.' points to the 'Switch Off' section in the 'Function' panel.

## 9 Advanced Features- App configurator

This chapter describes how the DALI Smartphone APP can be configured and customized with the DALI Professional software.

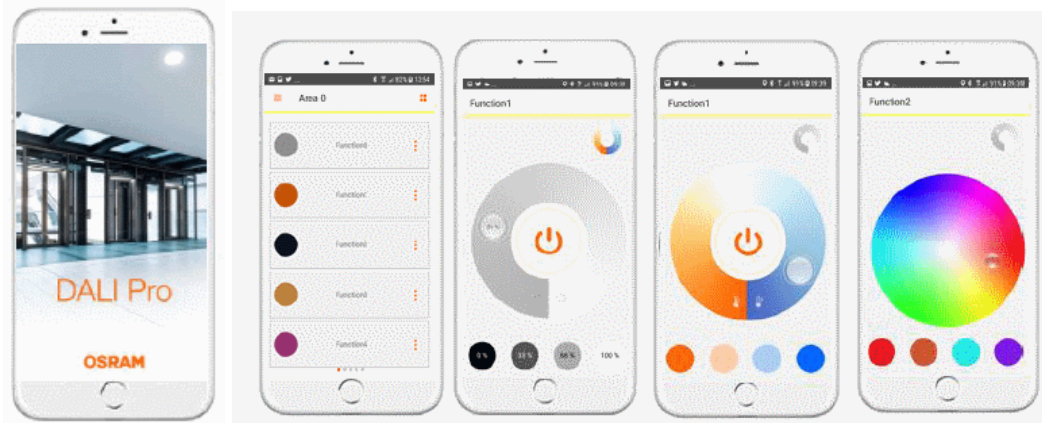

### 9.1 General Requirements

To control a DALI PRO controller with a smartphone, the following additional equipment is needed:

- WiFi router to provide the WiFi network.
- RJ45 Cat 5 patch cable between the wireless IT-Switch and the controller(s).

#### 9.1.1 Prerequisites:

- The DALI controller(s) and smartphone(s) must be connected to the same wireless local area network (WLAN). INVENTRONICS recommends assigning a static IP address to the DALI controller(s).
- All devices (controllers and smartphones) must be on the same subnet.

#### Network Parameters Recommendations:

- Assign a static IP address to the DALI controller(s).
- Use the subnet mask: 255.255.255.0.
- Ensure UDP messages are not blocked (DALI PRO CONT 4).
- Ensure port 27116 (TCP/IP) is not blocked (DALI PRO 2 IOT)

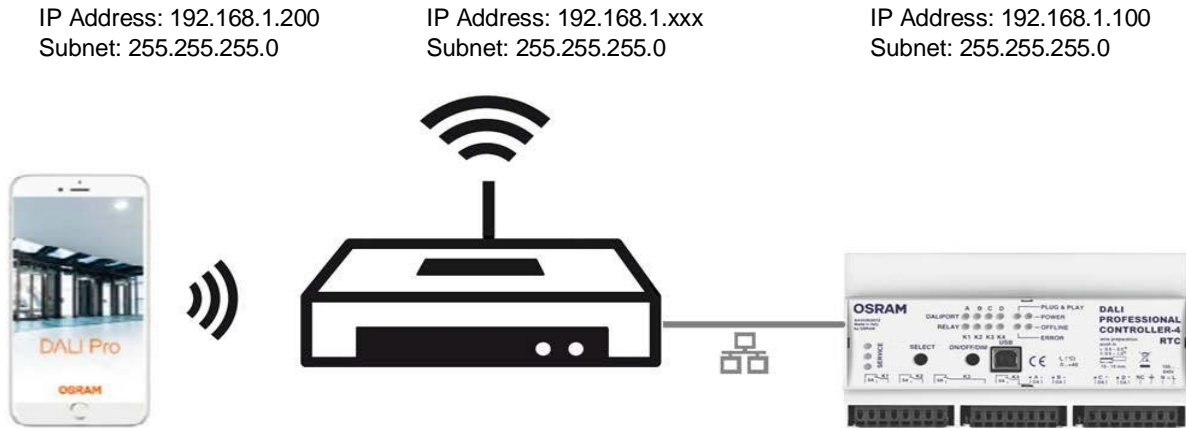

The DALI PRO Control APP doesn't work over the cloud.



The DALI PRO Control APP doesn't work with different sub nets.

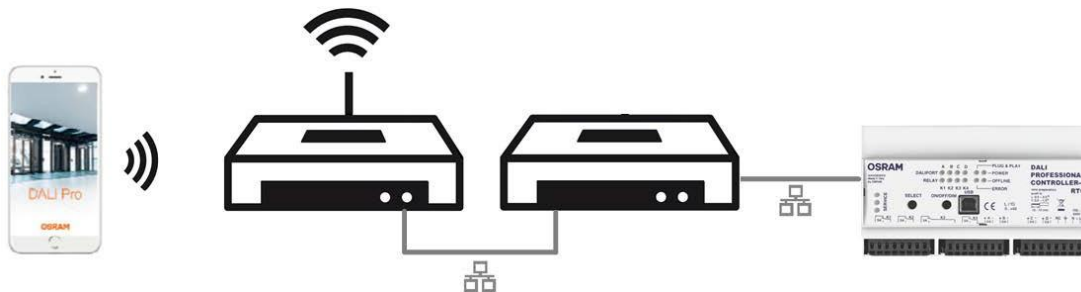

## 9.2 Features

The APP Configurator in the DALI Professional software provides the following features:

- Clear and Intuitive Structure: Configure the APP effortlessly using a user-friendly tree structure.
- Customizable Presets: Apply and adjust multiple elements with flexible preset options.
- Room Grouping: Organize rooms into views that appear as pages within the APP for easier navigation.
- Familiar Configuration: Set up the APP using the same approach as standard DALI PRO settings.
- User Access Control: Manage access restrictions with built-in user control features.

### 9.3 Configuring the APP

The **APP configurator** is located in the device tree in the *Advanced features* section.

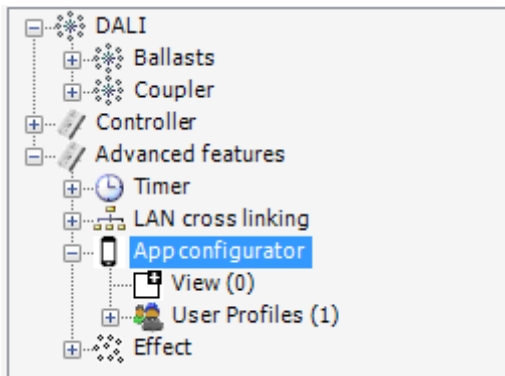

#### 9.3.1 Defining the views

In the APP, the elements will be grouped in views. Each view defines a page in the APP. For example, the views can represent different rooms:

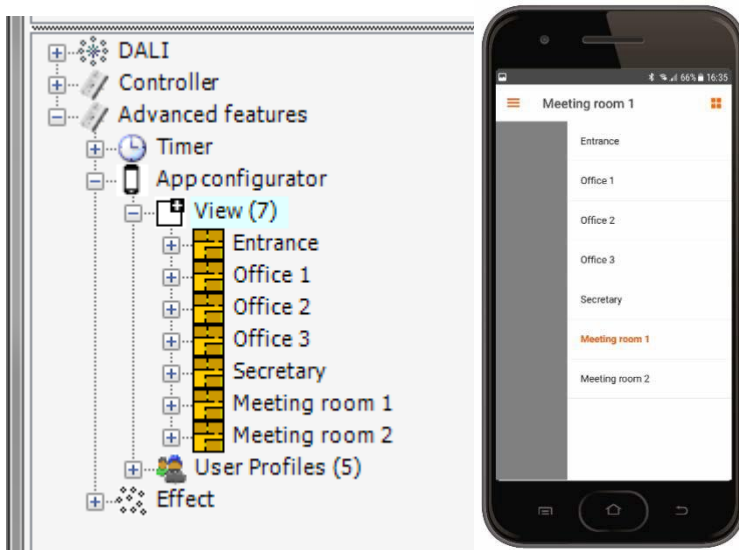

##### 9.3.1.1 Adding a view

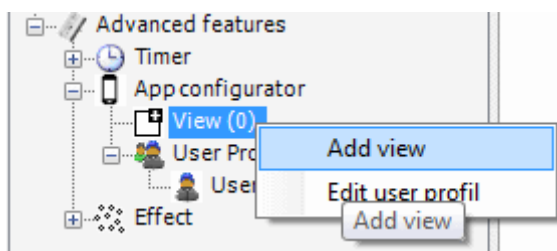

- In the device tree, right-click on **APP Configurator > View > Add View**. This will create a new view named **View\_n** in the tree.

- In the Properties window, rename the view by modifying the **Title** property (e.g., to **Office\_1**).

### 9.3.2 APP elements

Following APP elements are supported:

- **Button element**

A simple button that can initiate an action, such as switching the light on or off, with or without feedback.

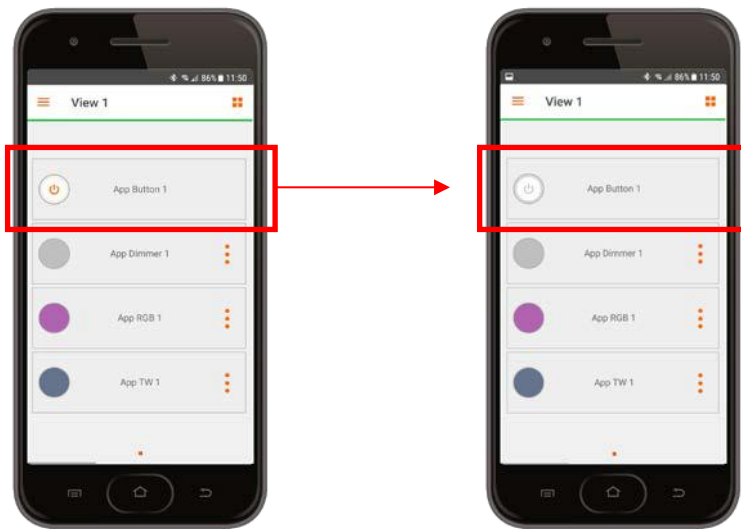

- **Dimmer element**

A button element for switching the light on or off and a dimmer element for adjusting the dimming level.

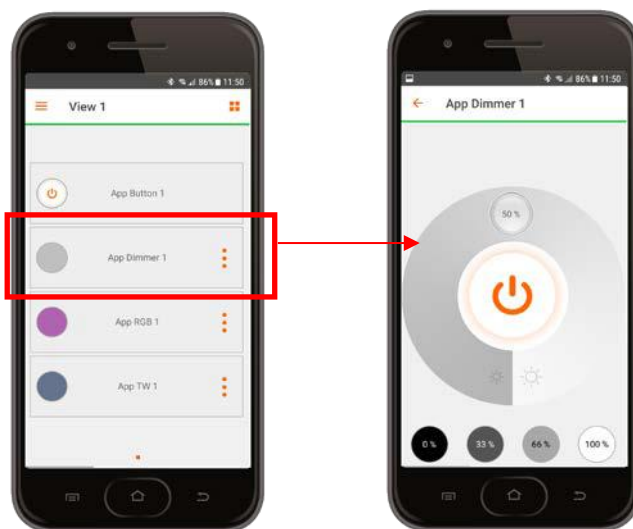

- **RGB/W elements**

A button element for switching the light on or off, a dimmer element for adjusting the dimming level, and an RGB/W element for controlling the color.

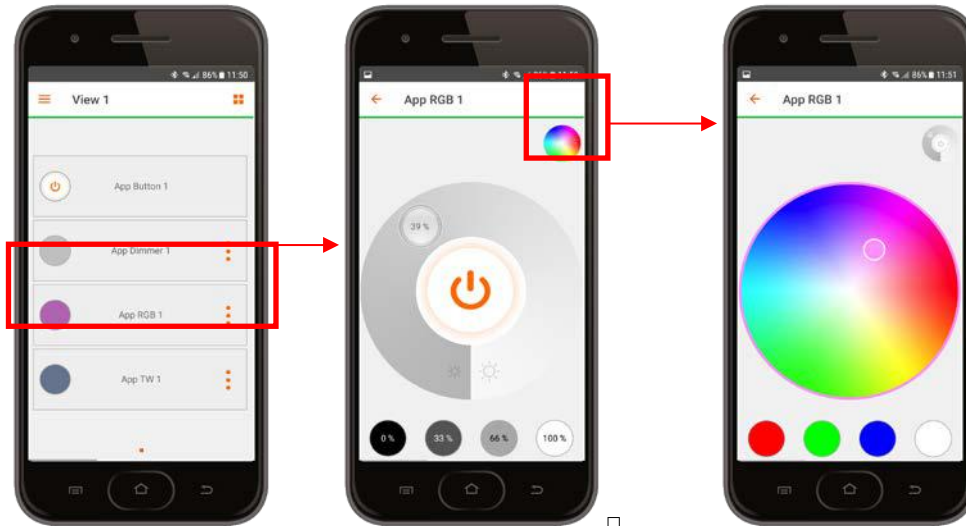

- **TW element**

A button element for switching the light on or off, a dimmer element for adjusting the brightness level, and a Tunable White (TW) element for controlling the color temperature.

### 9.3.2.1 Adding APP elements to the view

To add APP elements to the view:

- In the device tree, right-click on **APP Configurator > View > View > Add Devices**. The **Add Devices** window will appear.
- Select the number of APP devices you want to add and confirm. The devices will then be created in the tree.

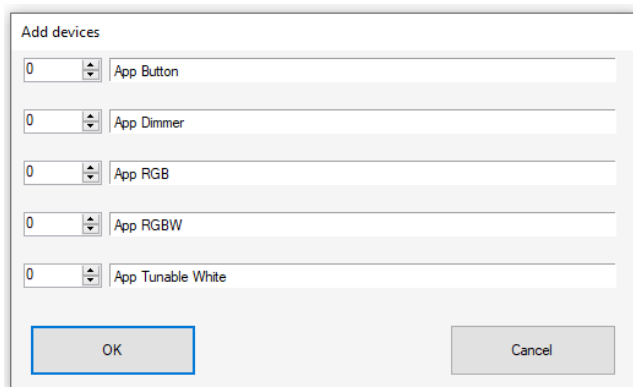

- You can modify the properties of each element as needed. Refer to the following table for details.

APP element properties:



Property	Description
Title	Set the name of the element
Label	Set the label of the element in the APP
Comment	Add a comment for further information
Zones	Show zones where the element is used.
Visible in	Show the views where the element is integrated.
User profile	Show the user profiles where the element is enabled.
Color temperature show numeric value	Only for APP TW! (Yes/No)

### 9.3.2.2 Configuring the elements

#### Zone: Zone 1

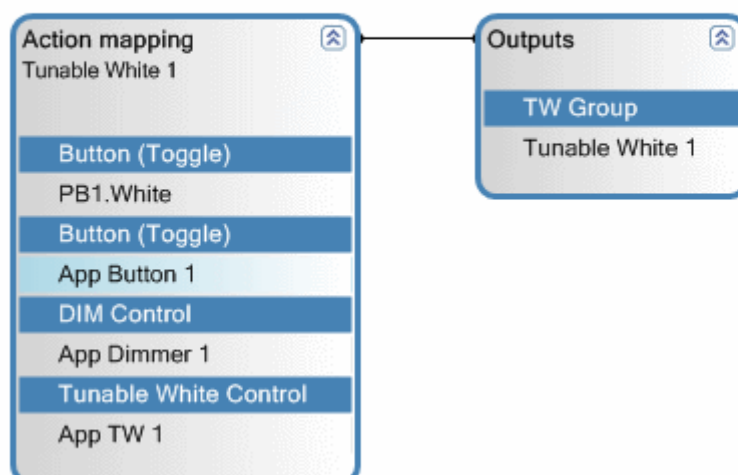

- To assign an APP element to an output device, drag both devices to the Graph panel.
- Connect Inputs and Outputs and configure the properties (*See the example in the upper picture for an Action Mapping with APP elements for a TW device.*)
- Configure the devices in the Properties window.
- You can rearrange the sort order of the APP elements:  
Drag & drop the elements to the position you want or use the functions *Up*, *Down*, *Delete*, *Move to other view*.

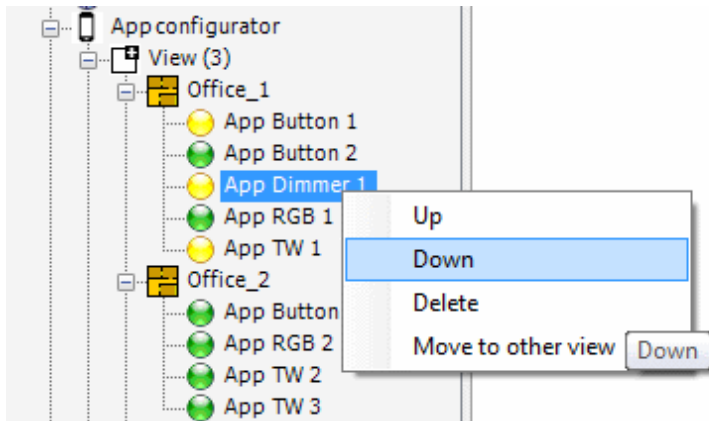

### 9.3.2.3 APP element properties

The following properties can be set for APP elements:

Option	Description	Parameters/Examples
<b>Fade Time (only visible for button element)</b>	Duration to dim to the new brightness level.	Default (uses fade time stored from the ECGs) No fade 0.7 – 90.5 s
<b>Short push</b>	Select action for a Short push on a button.	<i>See Short push actions</i>
<b>Show state</b>	Displays the status of the connected output (Color or shade of grey to indicate the dimming level)	Yes/No
<b>Delayed action (only visible for button element)</b>	Define up to two delayed actions for a Short push. If one or two actions will be configured, the additional properties for each action will be displayed (See the following tables).	No 1 2

### 9.3.2.4 Short push actions for button and dimmer elements

The following functionalities are available for Short push actions for button and dimmer elements.

Short push action	Description	Parameters/Examples
<b>Disabled</b>		
<b>Off</b>	Switch off the light.	
<b>Go to level</b>	Light on – dim brightness to parameter value.	Level (0 – 100 %)
<b>Go to last level</b>	Light on – with values from the situation before the last light off.	

<b>Go to Scene</b>	Light on to a configured scene, selected by name. See 4.3 <i>Add and configure a TW scene.</i>	Scene name (only selectable if existing)
<b>Go to next scene (only for button element)</b>	Light on to the scene, selected by name. If Scene 1 is already running, Scene 2 will be recalled by pressing the button – loop with each button press. See 4.3 <i>Add and configure a TW scene</i>	Scenes count (numbers, up to five scenes possible), Scene names
<b>Toggle (level)</b>	Toggle between off and the light value from the additional parameter level.	Level (0 – 100 %)
<b>Toggle (last level)</b>	Toggle between off and the level value from the situation of the last light on.	
<b>Toggle (scene)</b>	Toggle between off and the scene, selected by name.	

### 9.3.2.5 Short push actions for TW element

The following functionalities are available for Short push actions for Tunable White elements.

Short push action	Description	Parameters/Examples
<b>Disabled</b>		
<b>Off</b>	Switch off the light.	
<b>Go to level / color temperature</b>	Light on – dim brightness to parameter value. change color temperature to parameter value	Level (0 – 100 %) Color temperature (min. – max.)
<b>Go to last level / color temperature</b>	Light on – with values from the situation before the last light off.	
<b>Go to Scene</b>	Light on to a configured scene, selected by name. See 4.3 <i>Add and configure a TW scene.</i>	Scene name (only selectable if existing)
<b>Toggle (level / color temperature)</b>	Toggle between off and the light value from the additional parameter level.	Level (0 – 100 %) Color temperature (min. – max.)
<b>Toggle (last level / color temperature)</b>	Toggle between off and the level value from the situation of the last light on.	Color temperature (min. – max.)
<b>Toggle (scene)</b>	Toggle between off and the scene, selected by name. See 4.3 <i>Add and configure a TW scene.</i>	

### 9.3.2.6 Short push actions for RGB/W element

The following functionalities are available for Short push actions for RGB/W elements.

Short push action	Description	Parameters/Examples
<b>Disabled</b>		
<b>Off</b>	Switch off the light.	
<b>Go to level / color</b>	Light on – dim brightness to parameter value. change color to parameter value	Level (0 – 100 %) Color (RGB/W values)
<b>Go to last level / color</b>	Light on – with values from the situation before the last light off.	
<b>Go to Scene</b>	Light on to a configured scene, selected by name.	Scene name (only selectable if exist)
<b>Toggle (level / color)</b>	Toggle between off and the light value from the additional parameter level.	Level (0 – 100 %) Color (RGB/W values)
<b>Toggle (last level / color)</b>	Toggle between off and the level value from the situation of the last light on.	Color (RGB/W values)
<b>Toggle (scene)</b>	Toggle between off and the scene, selected by name.	

### 9.3.2.7 Delayed action configuration options for button element

The following functionalities are available for button elements only.

Option	Description	Parameters/Examples
<b>Time Delay</b>	Step 1: Delay time until the first delayed action starts. Step 2: Delay time between the first and the second delayed action.	e.g. 05:00 for 5 hours
<b>Fade Time</b>	Duration in seconds to dim to the new brightness level.	e.g. 1.0 s for one second
<b>Action</b>	Delayed action type: - Off (switch off) - Go to level (in percent)	e.g. Go to level
<b>Level</b>	Set the brightness level in percent.	e.g. 50 %

### 9.3.3 Define user profiles

The visibility of the APP elements can be enabled/disabled by user profiles.

Per default, all configured elements are enabled in the pre-configured user profile **User\_1**.

This section describes the configuration of additional user profiles (up to maximal 30 profiles). The user profiles can be renamed and additionally a password can be set.

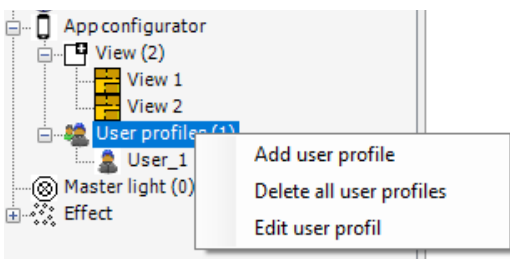
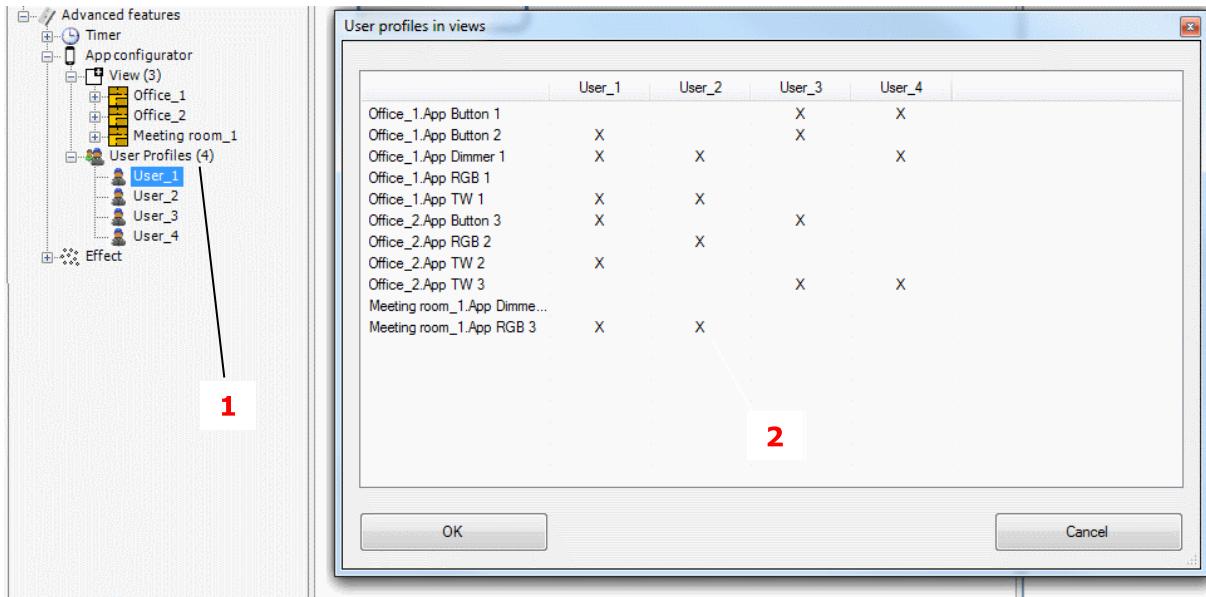

**To add a user profile:**

- In the device tree, **right-click** on User Profiles and select **Add user profile**.
- A new user profile, User\_n, will be created.

**To rename the user profile and set a password:**

- Edit the properties of the newly created user profile as outlined in the following table.

**To edit the visibility of APP elements in user profiles:**

- Right-click and select Advanced features > APP configurator > User Profiles > Edit user profiles.
- The User profiles in views window will appear, displaying all configured APP elements.
- In the list, check the boxes (X) to enable the desired APP elements.

**Properties of user profiles:**

Property	Description
Title	Set the name of the user profile
Password	Enter a password for the user profile
Comment	Add a comment for further information

## 10 Advanced Features- Zone Separator

### 10.1 Basic Rules

- Outputs (e.g., ECG, relay) used in a **zone separator** cannot be used in any other zone.
- If an output is already assigned to another zone, it will be **blocked** from being used in the zone separator.
- A zone cannot have the **zone separator feature added** if it contains outputs that are also used in other zones.
- After adding a zone separator, connected switches can be exchanged, but the **total number of switches cannot be changed**.

### 10.2 Situation: Two Parts with One Door

In the graph panel, a **zone separator control** is visible for each zone. A zone can be split into two parts by dragging and dropping a switch input onto this control.

- Switch inputs can include RTC time switches or LAN cross-linking switch inputs.

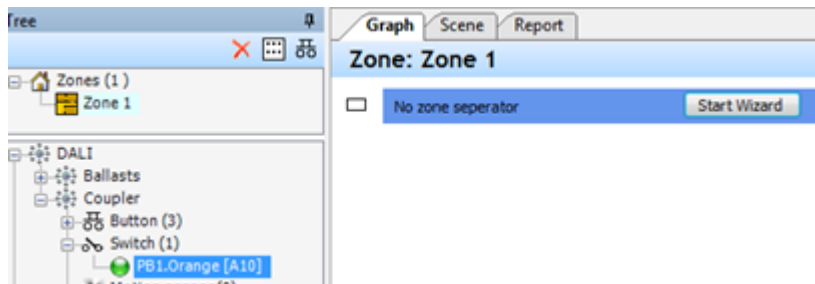

After splitting, the zone is divided into **two subzones**, each with independent configurations.

- The default names for the subzones are "[input name]\_Open" and "[input name]\_Closed".
- Subzone names can be customized to better describe the actual setup.

#### Example:

In a configuration with **two buttons and two lights**:

- **When the door is open**, both buttons control both lights simultaneously.
- **When the door is closed**, each button controls one light independently.

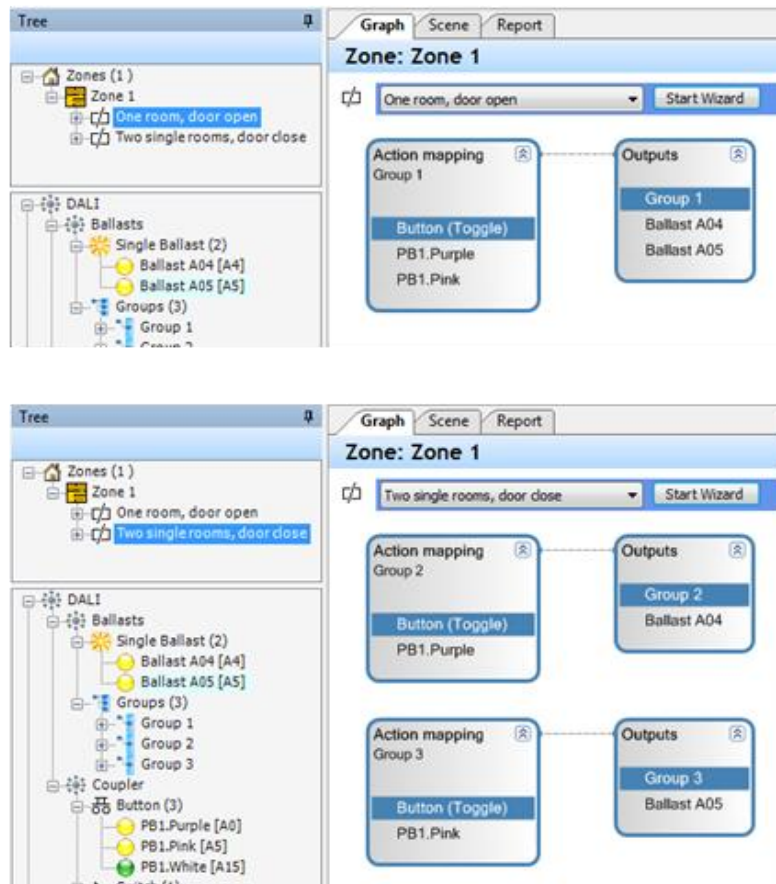

The switch used for the zone separator can be changed to any other **unused switch** by selecting the **"Start Wizard"** button.



### 10.3 Synchronization with Door State Changes

When entering the state of one of the subzones, the current light state can be synchronized if the **"Initial Synchronization"** property is set to **Yes**.

- Lights in a group (typically all groups connected to the functions) will automatically adjust all ECGs to the **highest brightness level** in the group.
  - **Note:** This will overwrite any existing light scene configurations.
- Example:**
- In part A, the light is on.

- In part B, the light is off.
- When the door opens, the light in part B will also turn on.

If the subzone uses a switch function and the **"Switch Synchronization"** property is set to **Yes**, entering the subzone state will trigger the **active switch-dependent function** to synchronize the switch position with the current light state.

### 10.3.1 Situation: More Than One Door (Two or Three)

When configuring a zone separator using the "Start Wizard" button, it is possible to select multiple switches for the zone separator.

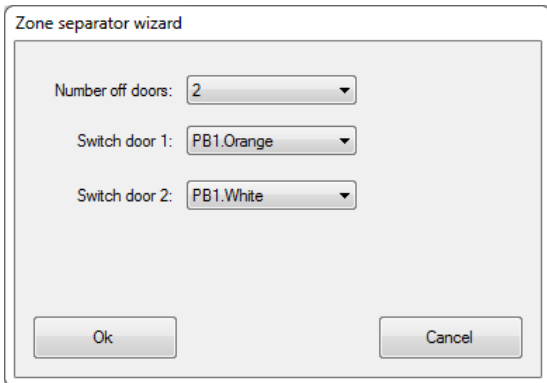

The automatically generated subzone names follow a structured naming convention. For example, with two switches:

- [zone name]: 0-0
- [zone name]: 0-1
- [zone name]: 1-0
- [zone name]: 1-1

The switching states associated with each subzone are displayed in the properties section of the subzone.

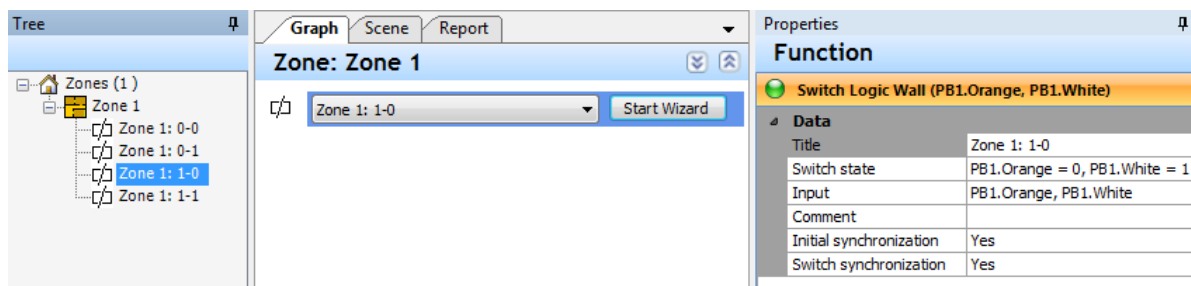

For three doors, eight independent subzones will be created automatically.

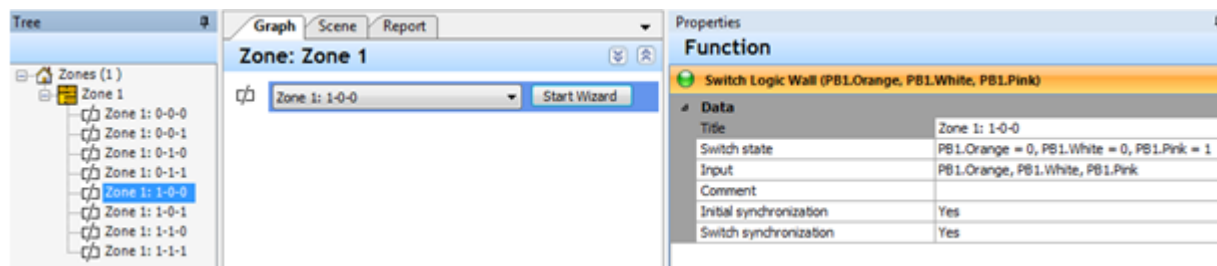



The switches used for the zone separator can be changed to any other unused switches by selecting the **"Start Wizard"** button again.

## 11 Advanced Features- Step Sequencer

A time-dependent series of functions is referred to as a sequence. Functions within a sequence can be linked to different outputs. Sequences can be started, stopped, and their playback speed adjusted.

The step sequencer functionality becomes visible in the tree after activation.

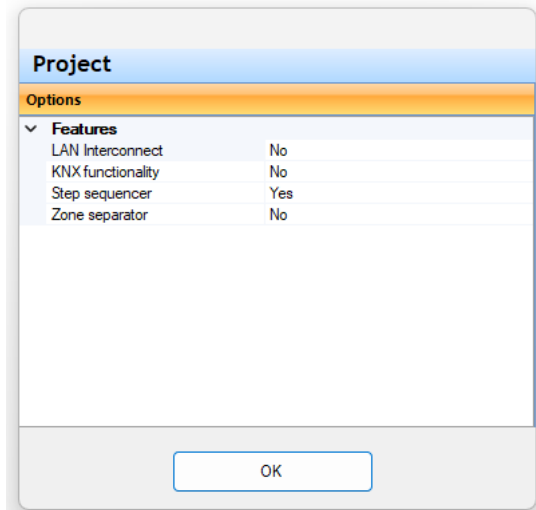

In the graph view, sequences are displayed with an additional column placed before the action mapping column.

### 11.1 Representation of Sequences in the Graph View

Time-dependent functions are grouped with other functions, such as buttons, within the action mappings. An additional column, located to the left of the action mappings, displays the **sequence box** along with **sequence state control inputs** (e.g., start, stop).

The sequence box is connected by lines to all action mappings that include a corresponding time-dependent function.

Additional column for controlling of the step sequencer itself (start/stop/speed...)	Column for time depending functions together with the normal functions (button, motion detections. ...)	Column for the output
---	---	-----------------------

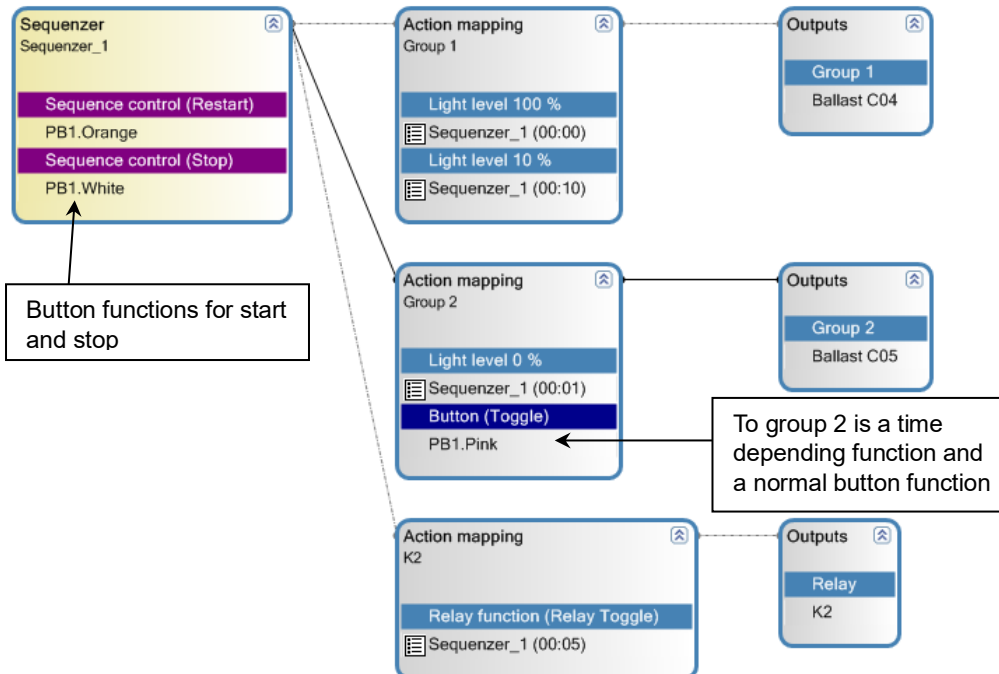

## 11.2 Creating sequences

Sequences are created in the **tree view** and can be dragged into the **graph view**, just like other devices.

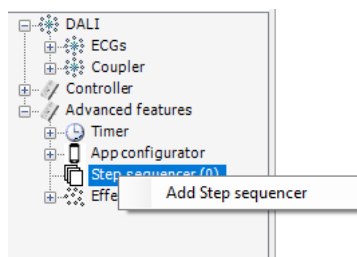

Each time a sequence is connected to an output, a new time-dependent function is created, allowing the relative execution time to be set individually. There are two ways to modify the timing:

- **Absolute Time Adjustment:** Changing the absolute time may alter the order of individual time functions.
- **Delay Time Adjustment:** Adjusting the delay relative to the previous function preserves the order, as the absolute times of all subsequent functions are automatically updated.

To assist with sequence creation, each time-dependent function includes an icon that creates a duplicate of the function with identical parameters, set for 10 seconds later, and connected to the same outputs.

**Delete this function**

Make a copy of this function with same parameters and to the same outputs, but only for 10 seconds later.

Change the absolute execution time of this function. The order of the functions may change.

Change wait time to previous function. The times of the following functions are adjusted automatically.

Lichtwert (03:10)	
Change Light Level	
<div style="display: flex; justify-content: space-between;"> <span>✖</span> <span>📄</span> </div>	
<b>1. Timing</b>	
Time Absolut	03:10
Delay	01:05
<b>2. Data</b>	
Fade Time	Default
Action	Go to level
Level	10 %

Additionally, selecting the **sequence box** in the left column allows you to **display and edit all time-dependent functions**. General sequence properties, such as **looping**, can also be configured from this view.

If "Loop" is set to "Yes," the sequence runs continuously until it is manually stopped. The "Delay" defines the waiting time between the completion of the last step and the restart of the sequence.

If "Run exclusive" is set to "Yes," the sequence stops automatically if another sequence is started on the same output.

If "Start with power on" set to "Yes", the sequence is automatically started after main line interruption.

The connected output for the sequence step.

1. Sequencer	
Title	Sequencer_1
Loop	Yes
Delay	20 s
Run exclusive	Yes
Start with power on	No
<b>2. Step-1 (Group 1)</b>	
Time Absolut	00:00
Delay	00:00
Fade Time	Default
Action	Go to level
Level	100 %
<b>3. Step-2 (Group 2)</b>	
Time Absolut	00:01
Delay	00:01
Fade Time	Default
Action	Off
<b>4. Step-3 (K2)</b>	
Time Absolut	00:05
Delay	00:04
Action	Relay Toggle
<b>5. Step-4 (Group 1)</b>	
Time Absolut	00:10
Delay	00:05
Fade Time	Default
Action	Go to level
Level	10 %

## 11.3 Logic Functions in Sequences

A sequence can be stopped based on the current light state of a group, using conditions such as "**Stop if light off,**" "**Stop if light on,**" or "**Stop if light on and not scaled.**"

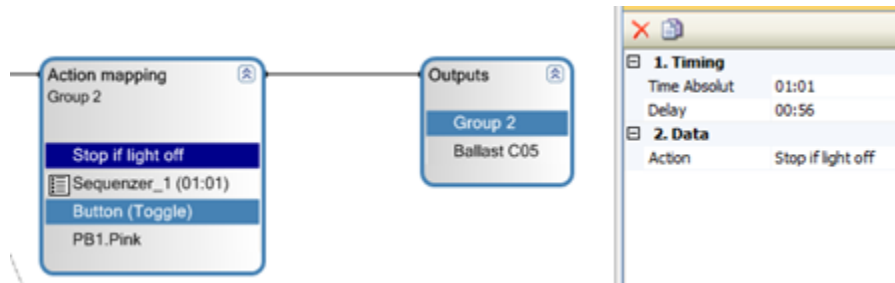

### 11.3.1 Logic Functions for a Simple Swarm Function

In this example, there are two groups: **Group 1** and **Group 2**.

#### a. Movement in Group 1:

- Group 1 enters **regulation** mode.
- Group 2 enters **scaled regulation**.
- After 10 minutes, Group 1 enters **scaled regulation**.
- After another 10 minutes, both Group 1 and Group 2 turn off.

#### b. Movement in Group 2:

- Group 2 enters **regulation** mode.
- Group 1 enters **scaled regulation**.
- After 10 minutes, Group 2 enters **scaled regulation**.
- After another 10 minutes, both Group 1 and Group 2 turn off.

#### c. Important Note:

If **Group 1** is already in **regulation** mode, movement in **Group 2** should not switch Group 1 to **scaled regulation**.

Each group is extended by a sequence that is trigger from the motion sensor from the other group.

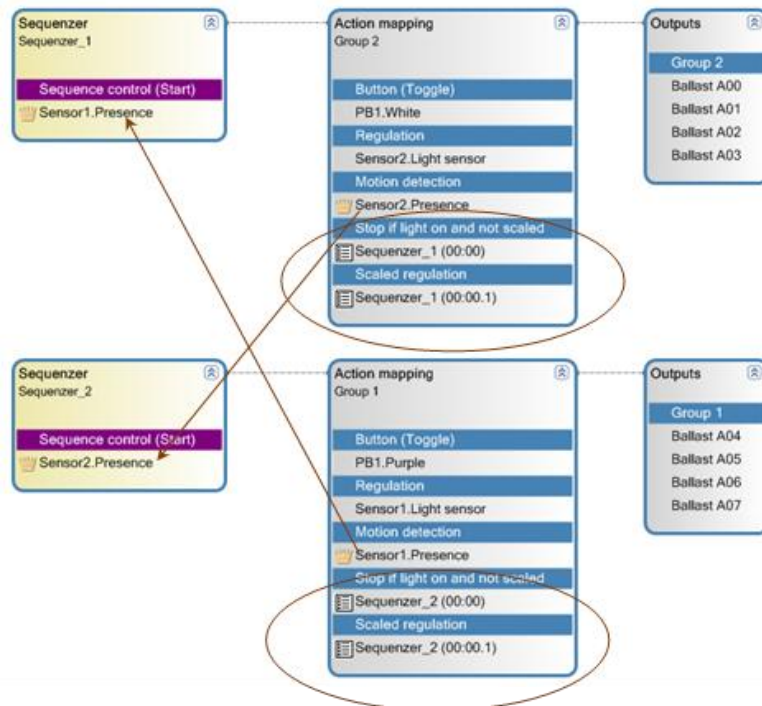

**Smallest possible delay 00:00,1 = 100 ms (to have a clear order)**

**Make the next sequence step**

**"Stop if light on and not scaled" is checking the state of the connected light. The next step will only be executed if the light is off or on with scaled regulation.**

**Start motion timer to switch off the light (after 20 min)**

**With next motion for "Sensor2.Presence" the light shall jump to normal regulation.**

1. Data	
Mode	Full automatic, one reduction
2. Motion detection	
Fade Time	Default
Action	Regulation
3. Step 1	
Time delay	10:00
Fade Time	Default
Action	Scaled regulation
Lowering to	20 %
Limit Level	No
4. Light Off	
Switch light off	Yes
Time delay	10:00
Fade Time	16.0 s

1. Timing	
Time Absolut	00:00
Delay	00:00
2. Data	
Action	Stop if light on and not scaled

1. Timing	
Time Absolut	00:00,1
Delay	00:00,1
2. Data	
Fade Time	Default
Action	Scaled regulation
Lowering to	20 %
3. Extended	
Motion delay timer	Yes
Motion detection can change	Yes

### 11.3.2 Step sequencer and relay

**Example 1: Switch on relay 10 seconds after the first detected motion, for 2 seconds (no retrigger).**

- The relay will be activated 10 seconds after the first motion detection.
- It will remain on for 2 seconds.
- The sequence will not be retriggered during this period.

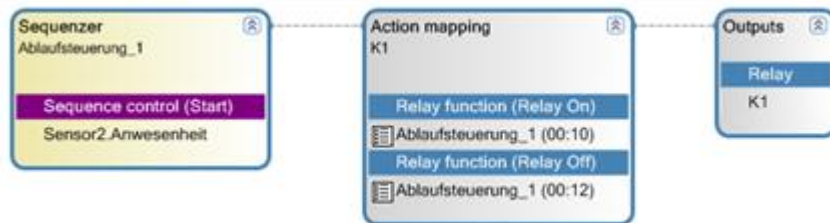

**Example 2: Switch on relay for 2 seconds, 1 minute after the last detected motion (with retrigger on each motion detection).**

- The relay will be activated 1 minute after the last detected motion.
- It will stay on for 2 seconds.
- The sequence will be retriggered with each new motion detection, restarting the 1-minute timer.

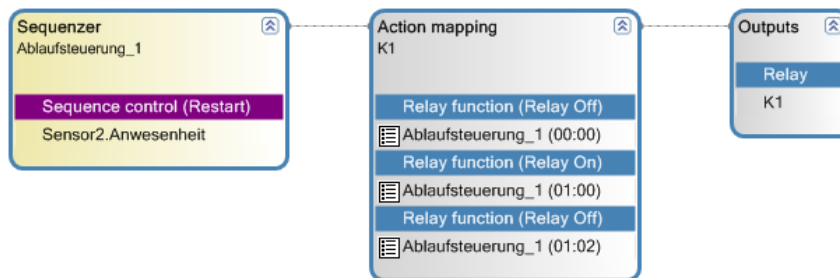

**Example 3: Switch on relay (for 30 seconds) only if the light has been on for more than 50 seconds.**

- The motion sensor triggers both the **normal motion function** for the DALI ECG and the **sequence**.
- The relay will turn on for 30 seconds, but only if the light has been on for more than 50 seconds.
- The sequence will not be retriggered during this time and will stop if the light turns off before the 50-second mark.

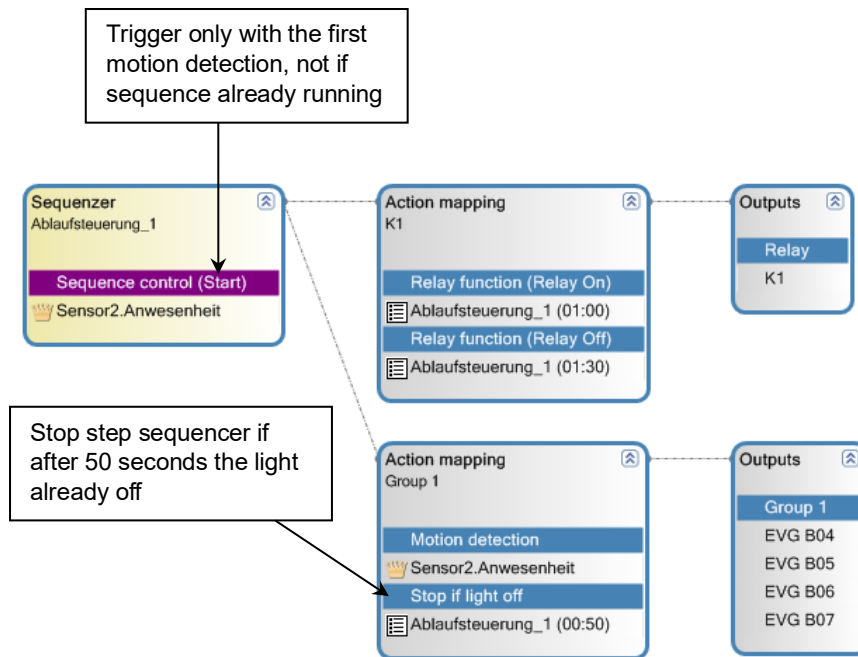

### 11.3.3 Lock/Unlock Motion Detection for Step Sequencer

When the motion sensor is used to start the step sequencer, its functionality can be temporarily suppressed using the **"Lock Motion Detection"** button. To re-enable the motion detection, the **"Unlock Motion Detection"** function can be used.

For the App button, the current lock state can be displayed if the **"Show State"** property is set to Yes.

If a switch (or RTC timer switch) is connected to the step sequencer to control the on/off state, the **"Lock Motion Detection"** and **"Unlock Motion Detection"** functions can be controlled through this switch.

There is only one lock/unlock state for each step sequencer, which applies to all connected motion sensors.

**Example:** The start of a short sequence triggered by motion can be suppressed by the App button labeled **"Lock Motion"**.

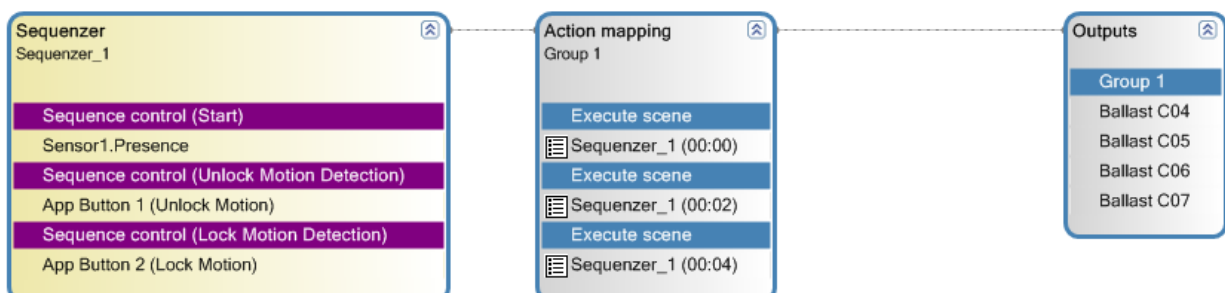

## 12 Virtual wiring (LAN Interconnection)

### 12.1 General

The LAN interconnection enables sharing of DALI coupler input signals between multiple DALI Pro controllers, facilitating the implementation of central functions. To minimize complexity, the number of connected controllers should be limited to four for DALI PRO CONT 4 RTC and 8 for DALI PRO 2 IoT.

To use this function the feature "LAN interconnectivity" must be enabled (1).

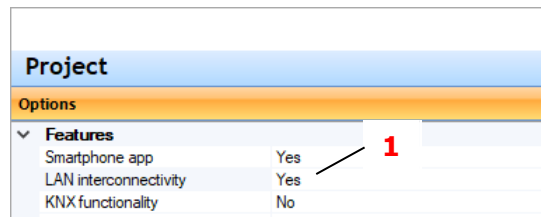

#### 12.1.1 Commissioning Process

Commissioning should be performed in two steps to ensure efficient setup and reliable operation:

- **Local Commissioning**

Commission each DALI Pro controller individually, configuring all local functionalities, including the addition of LAN inputs and outputs.

Perform the upload and test the local functionality to confirm proper operation.

The upload is crucial, as it ensures that the configured LAN inputs and outputs are visible to all other devices and the configuration software in the system.

- **Interconnection Setup**

Extend each configuration by adding the connection information to other controllers, establishing links between the different DALI Pro controllers.

**Note:**

Before starting the commissioning process, it is essential to develop a clear concept for the central functionality to ensure a well-organized setup.

#### 12.1.2 Key Considerations for virtual wiring

##### PC Tool Connection

Ensure that the PC tool is connected to the same LAN network as the DALI Pro interconnection during the generation of the connection.

##### Signal Sharing

Only the input signals are shared between controllers. The functionality, including all parameters, is executed locally on the DALI Pro controller connected to the light outputs.

##### Button Toggle Function



Avoid using the button toggle function for central functions, as it may lead to asynchronous behavior.

### Switch Input and Output Configuration

Each switch input should only be connected to one switch output. This prevents illogical states, such as one output being in the "on" state while another is in the "off" state.

#### 12.1.3 LAN (IP address) setup

For the interconnection functionality, it is important to assign fixed IP addresses to all DALI Pro devices and ensure that each device has a unique name for easy identification. To configure these settings, open the setup dialog by selecting "Controller" in the tree structure and then navigating to "LAN Properties".

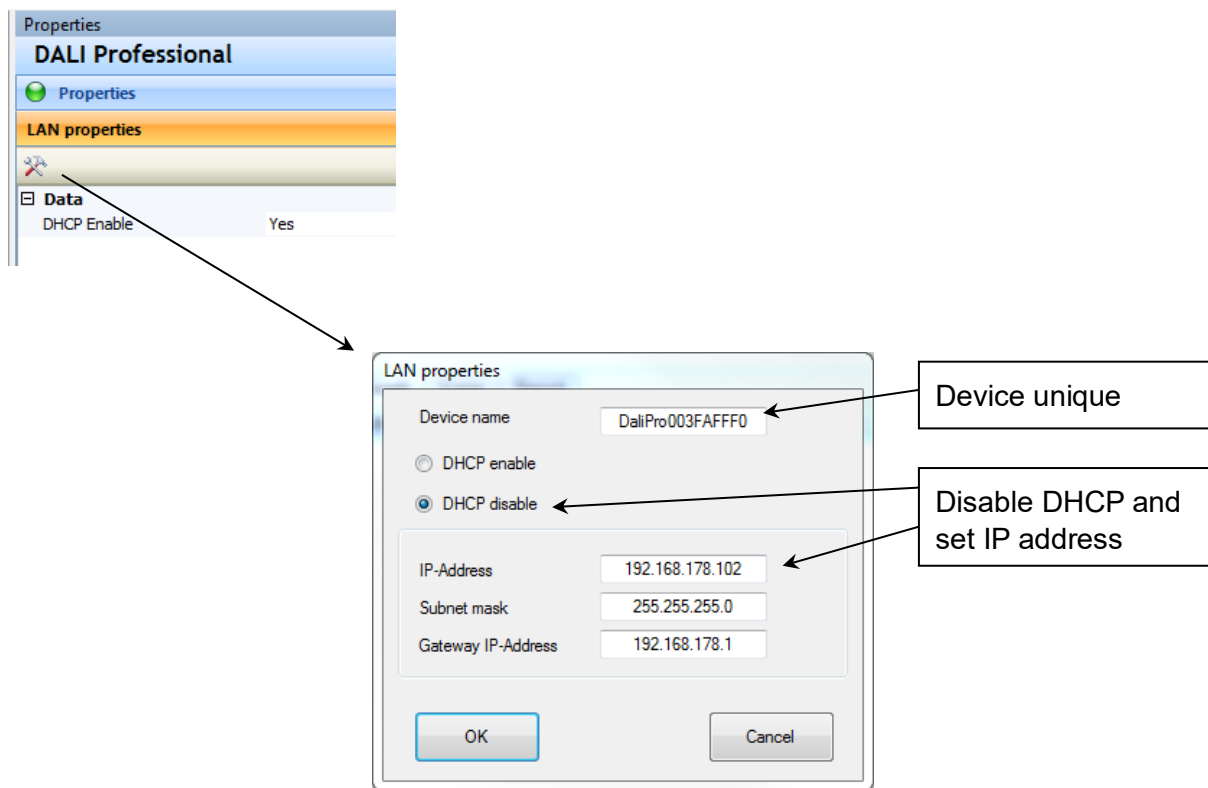

## 12.2 Example: Virtual wiring for a button

### Step 1: commissioning of the light output controller

Connect to the controller linked to the light output and search for the devices as usual. Add two interconnection button inputs, one for the "Light On" function and the other for the "Light Off" function.

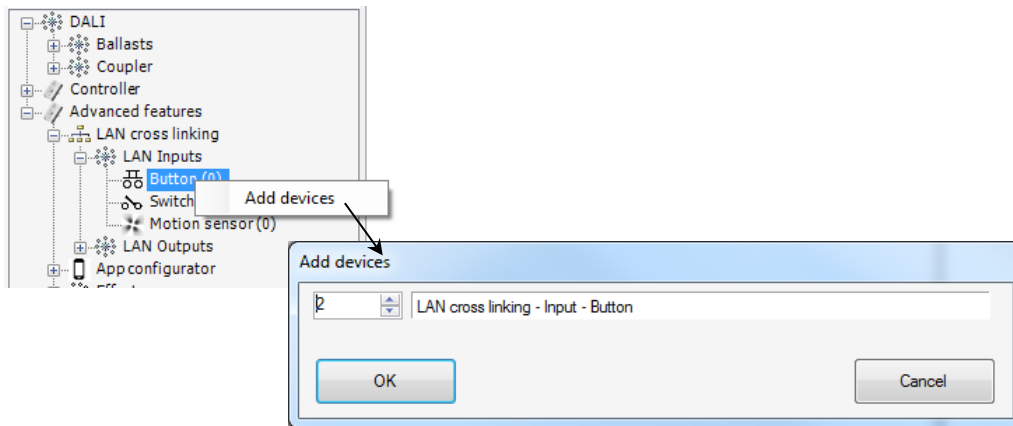

Next, connect both button inputs to the light output, enabling separate functionality for turning the light on and off. The configuration is performed in the standard way.

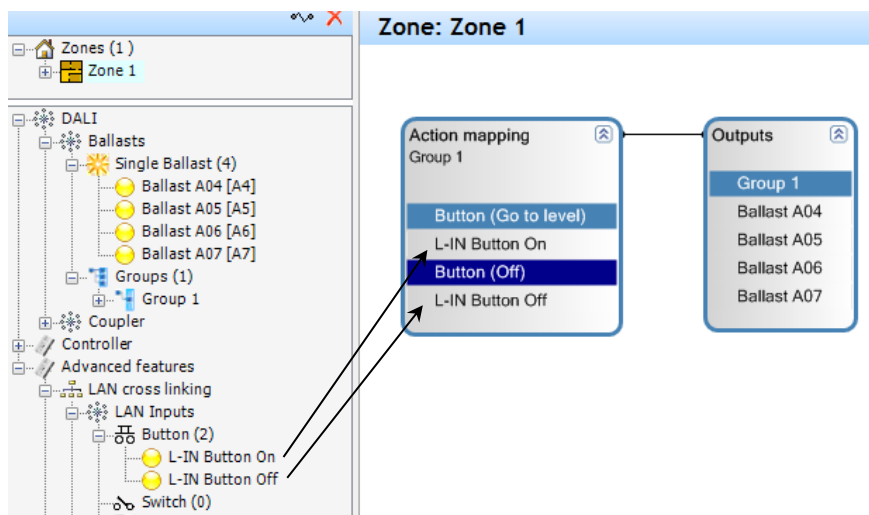

If the remote button is connected to more than one controller, avoid using the toggle function or the normal dimming function (which toggles the dimming direction after each long press) to prevent potential conflicts or unexpected behavior.

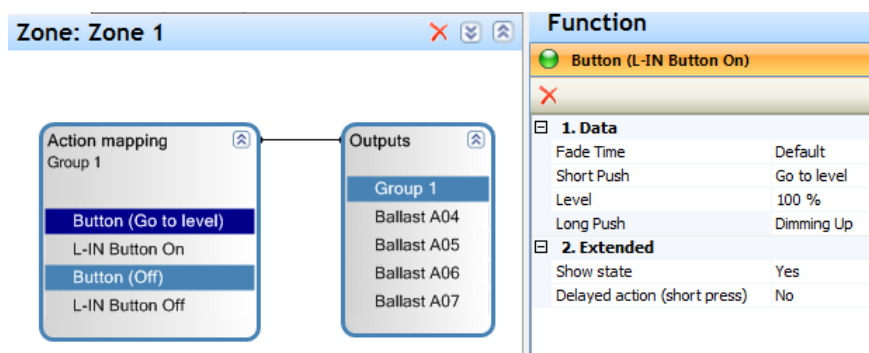

Finally, upload the project to apply the settings.

### Step 2: commissioning of the button input controller

Connect to the second controller with the button coupler and search for the devices as usual. Add two interconnection button outputs, one for the "Light On" function and the other for the "Light Off" function.

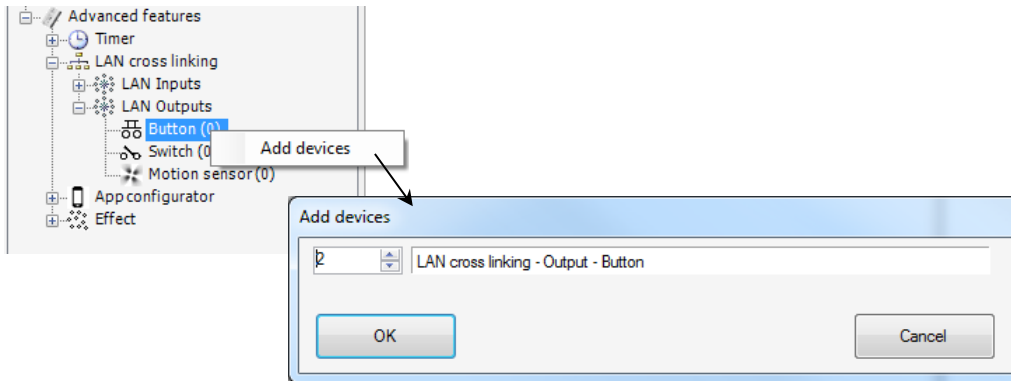

Next, connect the two LAN outputs to the corresponding real button inputs.

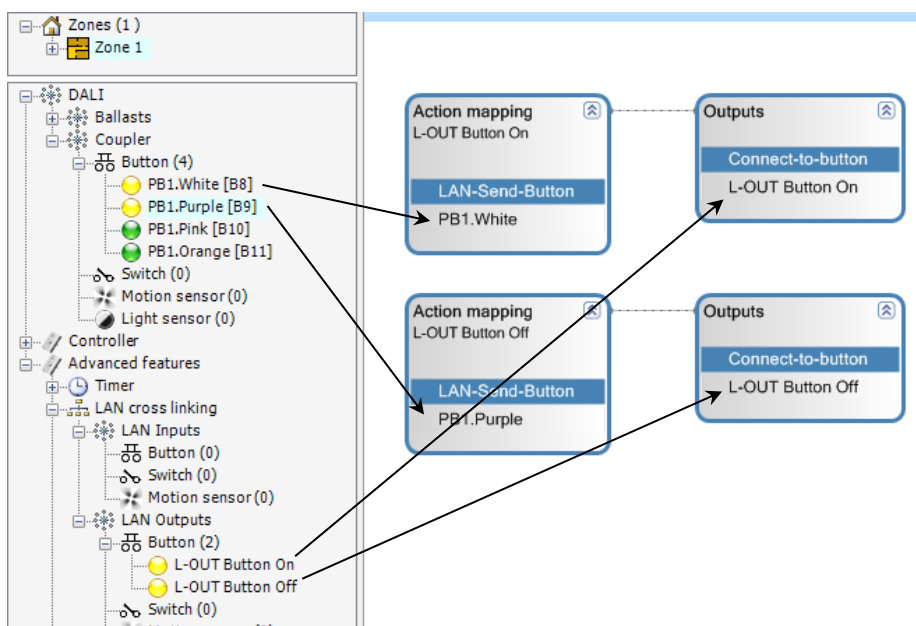

### !!! ONLY FOR DALI PRO CONT 4 RTC !!!

Establish the connection between the LAN button outputs and the LAN button inputs in the other controller using the context menu.

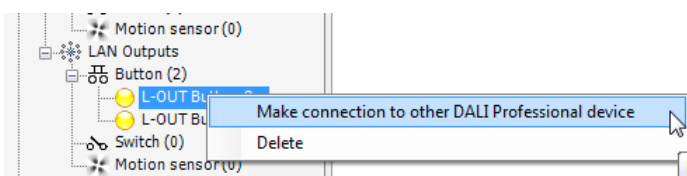

In the dialog, select the LAN button input and complete the connection using the "Connect" button.

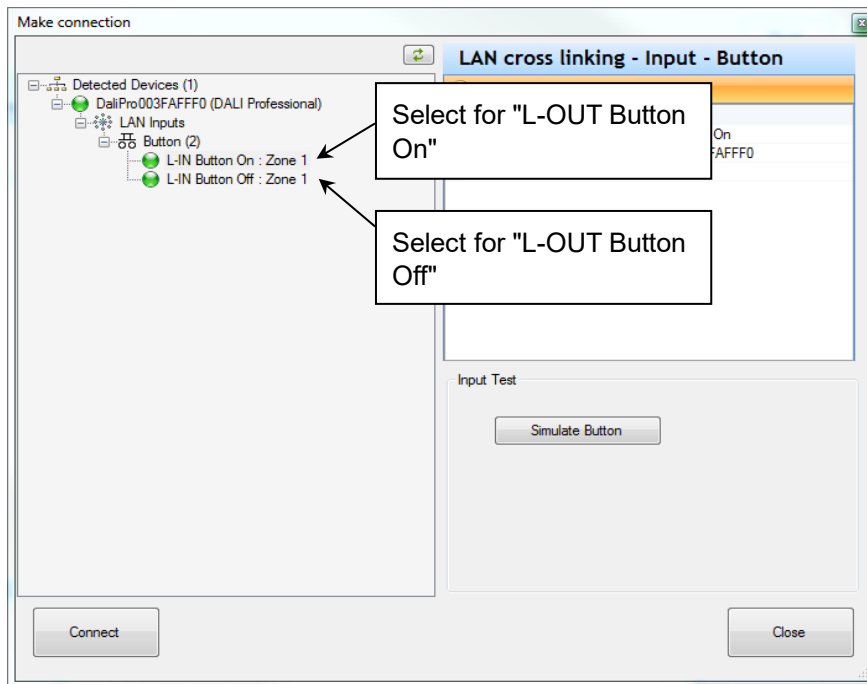

The connection dialog uses color-coded icons to indicate the current state of the devices:

Icon	Description
	Can be used
	Already used by this application
	Already used by the selected device

Each remote device can only be used once in the local application.

Once the connections are established, they will appear in the tree structure. Finally, upload the project to apply all configurations.

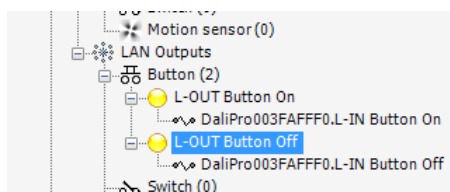

**!!! ONLY FOR DALI PRO 2 IoT!!!**

### 12.3 Virtual wiring between the controllers (For DALI PRO 2 IoT)

The setup of the interconnection begins after the configuration has been uploaded to all devices. While the configuration of individual devices can be modified later, the interconnection process operates independently of the local upload actions.

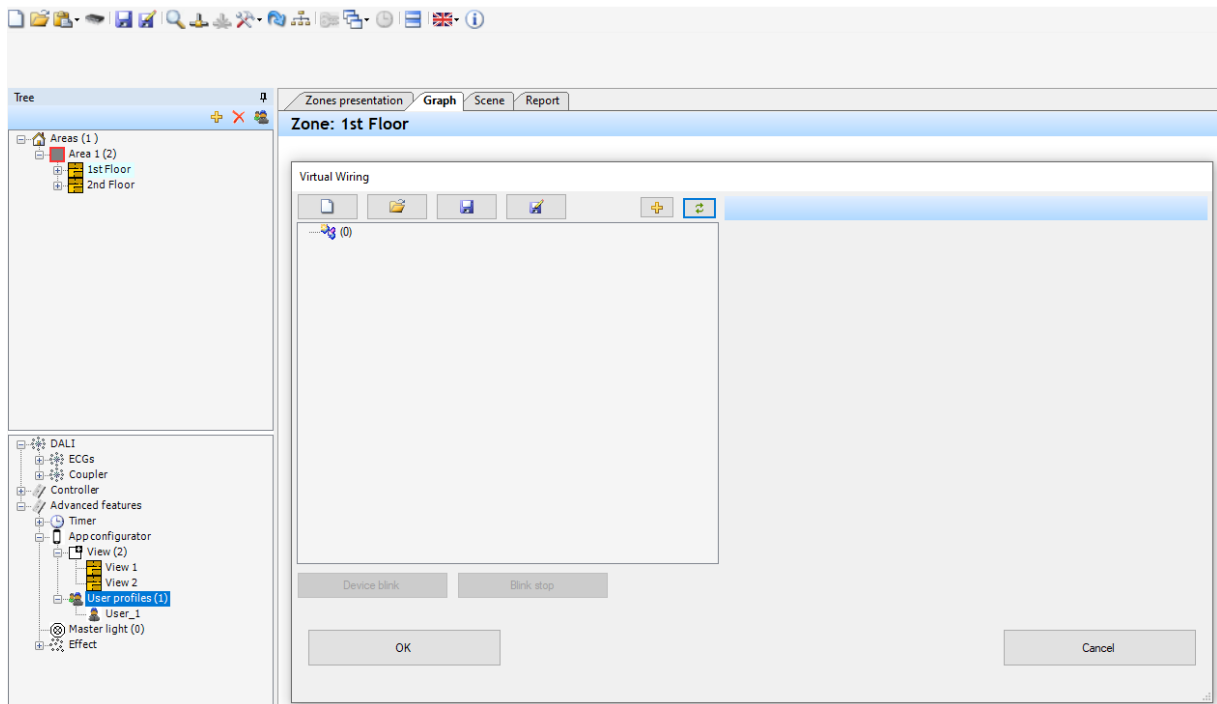

To start a new project, either click on the icon (4) or trigger a device search (5). The first step in setting up the interconnection is to select all the required devices. Log-in credentials are necessary for each device. Using the "Activated" property (6), you can specify whether a device is part of the project.

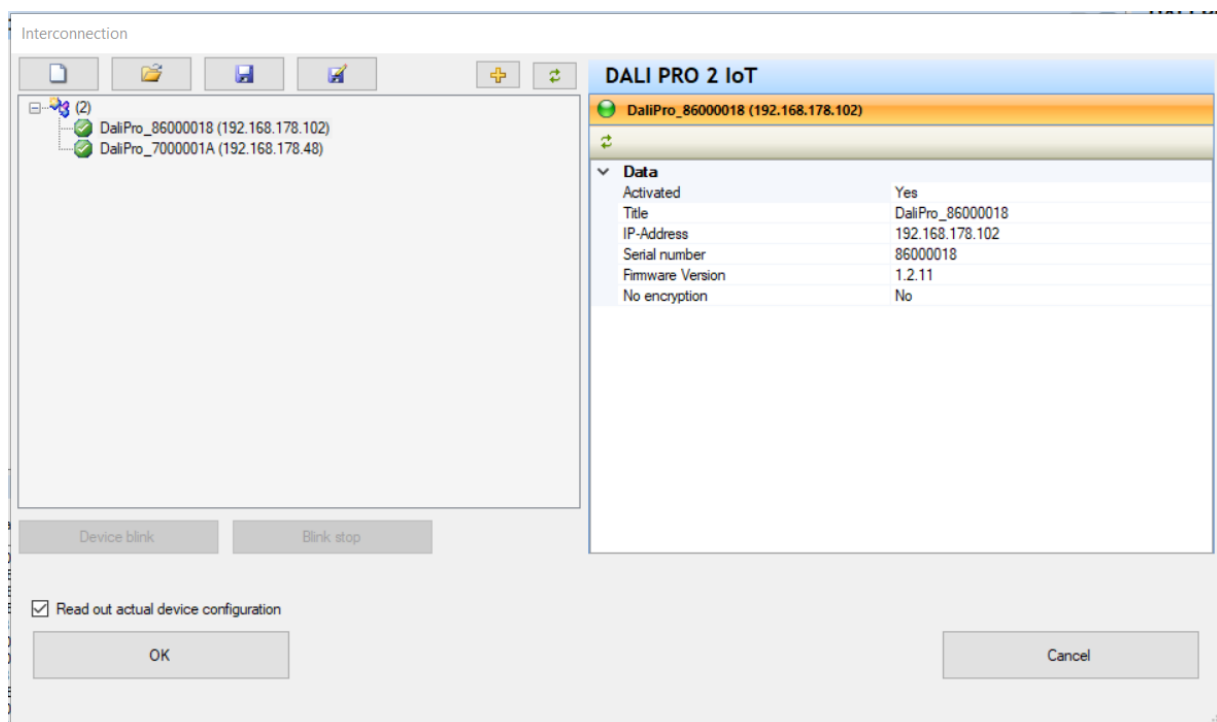

The list of selected devices can be saved to a file. This file also stores the certificates for communication with the devices, avoiding the need to log in to all devices again when the file is reloaded. To ensure security, the file must be password-protected (minimum 4 characters).

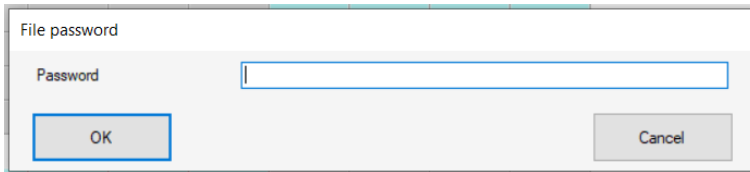

Once the devices are selected, the connection interface for each device will be read out. The current connections will be displayed in a matrix.

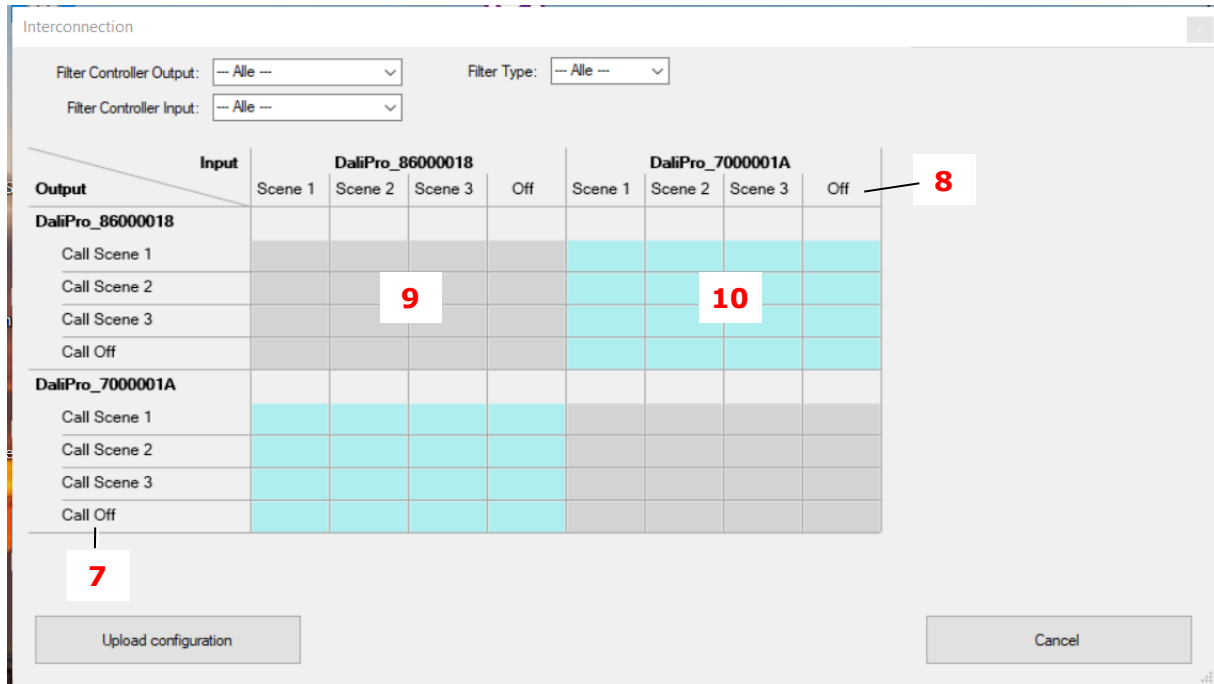

- On the left side of the matrix, each controller's outputs (7) are listed as rows.
- At the top, the inputs (8) of each controller are listed as columns.
- Grey fields (9) indicate that a connection is not possible, either because the inputs and outputs belong to the same controller or are of incompatible types.
- Other fields are color-coded based on the type of signal (e.g., button, motion sensor) (10).
- Selecting a field (11) creates a connection between the output in the row and the input in the column.

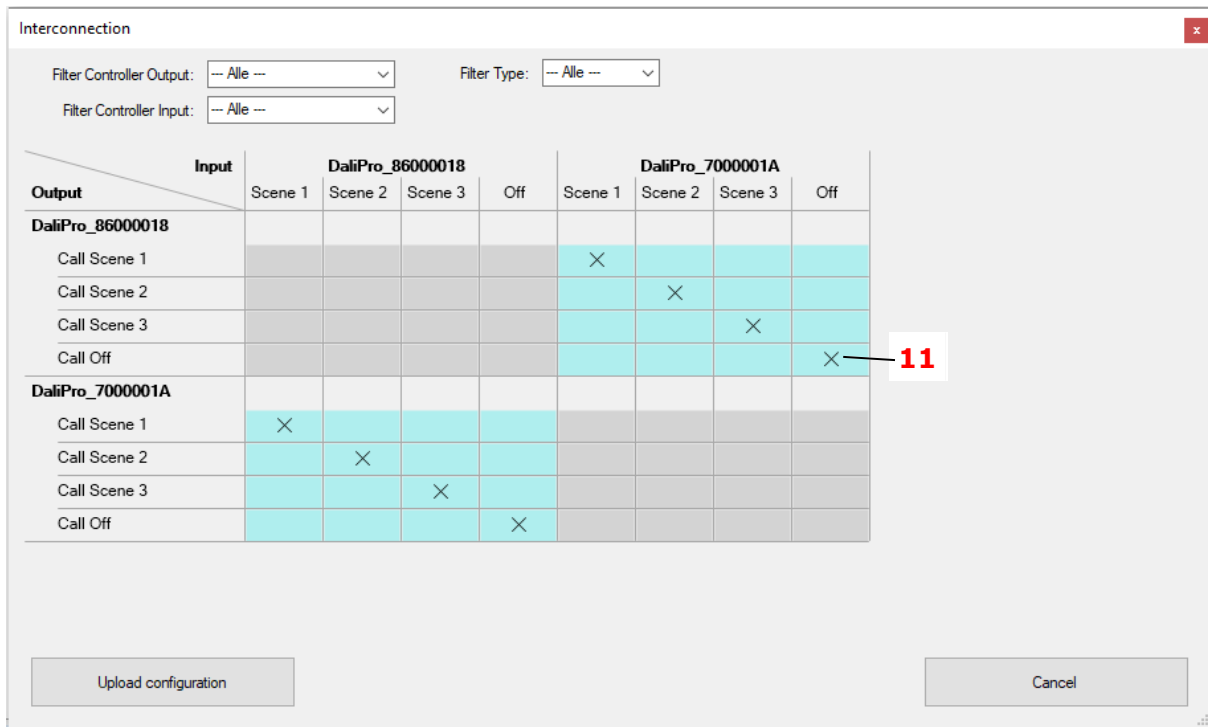

For larger applications, you can filter the displayed controllers and interface types to improve clarity (12).

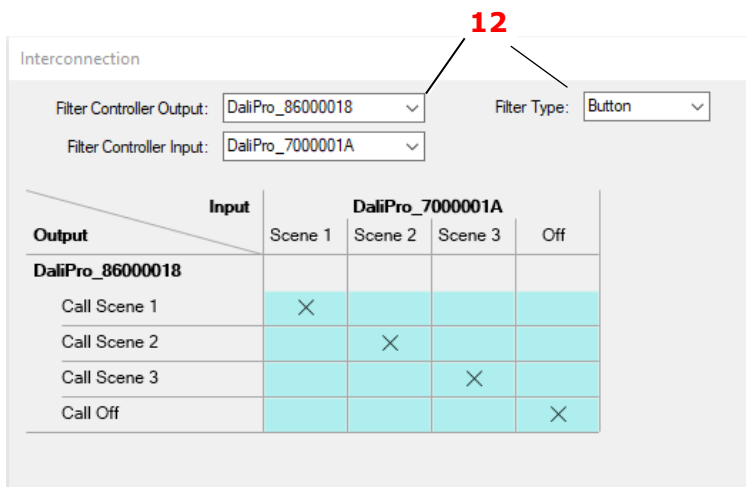

Finally, use the "Upload Configuration" option to store the selected interconnections in all devices.

### 12.3.1 Notes

If a device is part of the project but is currently not reachable, and connections to this device already exist (as a destination for messages), the device and its interfaces will be displayed in **blue**. If a device is not part of the project but connections to this device already exist (as a destination for messages), the device and its interfaces will be displayed in **red**.



## 12.4 More functions

### 12.4.1 LAN connection for motion detection

The functionality of the motion detection input is similar to that of a button input.

#### On the DALI Pro Controller connected to the ECG

- Add a **LAN Motion Sensor Input** and connect it to the ECG, functioning like a local motion sensor.
- The parameters for motion detection actions are identical to those of a local motion sensor.

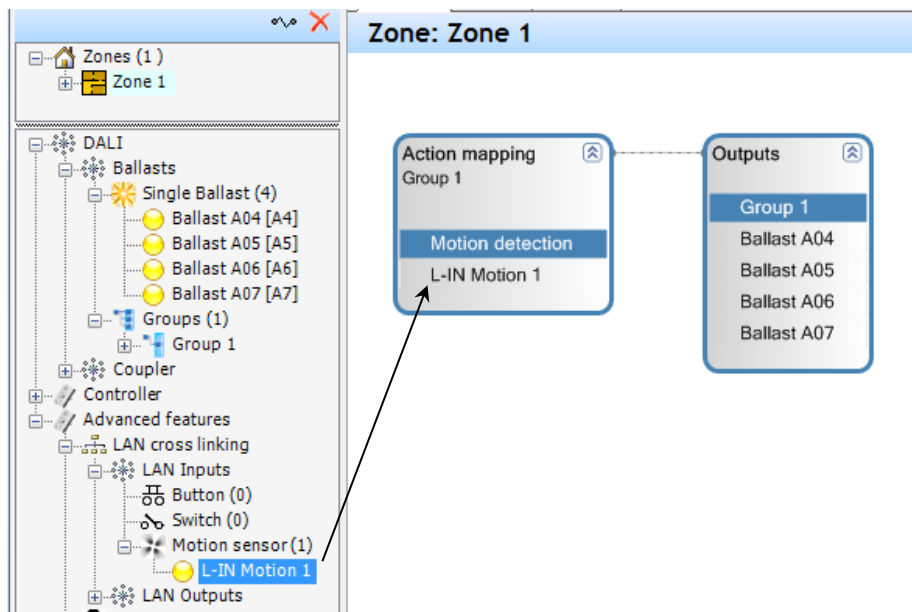

#### On the DALI Pro Controller Connected to the Motion Sensor

- Add a **LAN Output for Motion Sensor** and connect it to the physical motion sensor.

The connection to the LAN Motion Sensor Input is configured in the same way as for a button input connection.

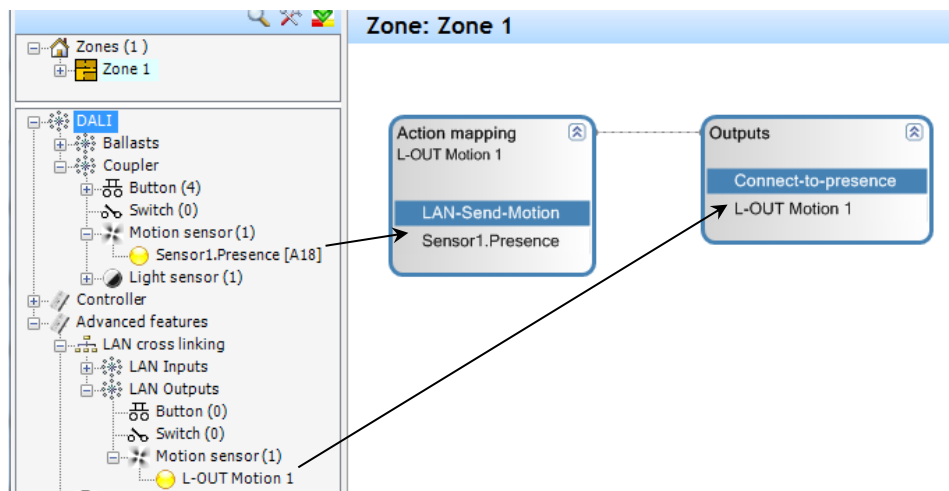



### 12.4.2 LAN connection for switch

Switch inputs require special handling.

- Only **one switch output** should be connected to a single switch input to avoid conflicting states, such as one input sending "ON" while another sends "OFF."
- A **button input** can be switched to **switch mode** via the context menu.

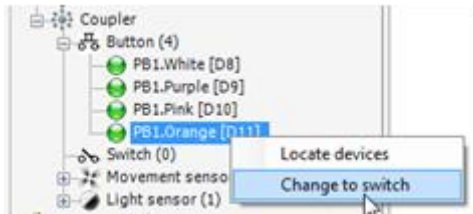

#### DALI Pro Controller Connected to the ECG

- Add a **LAN Switch Input** and connect it to the ECG as you would a local switch.
- The parameters for the switch action remain identical.

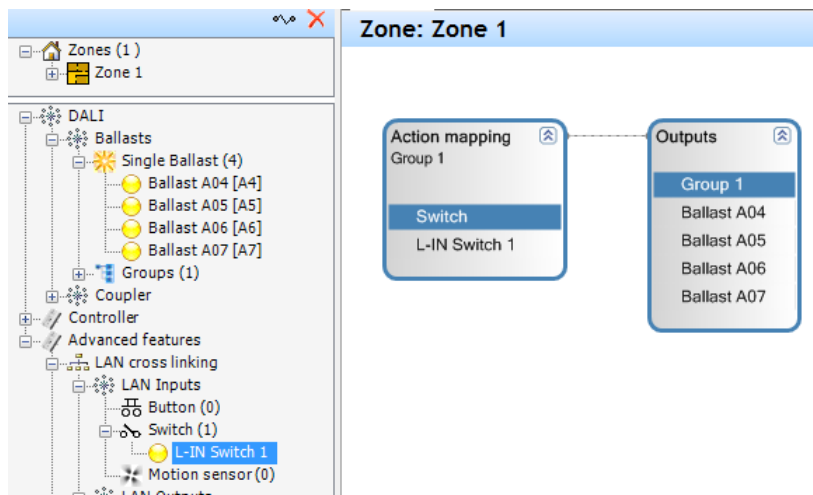

#### On the DALI Pro Controller connected to the physical switch

- Add a **LAN Output for Switch** and connect it to the physical switch.

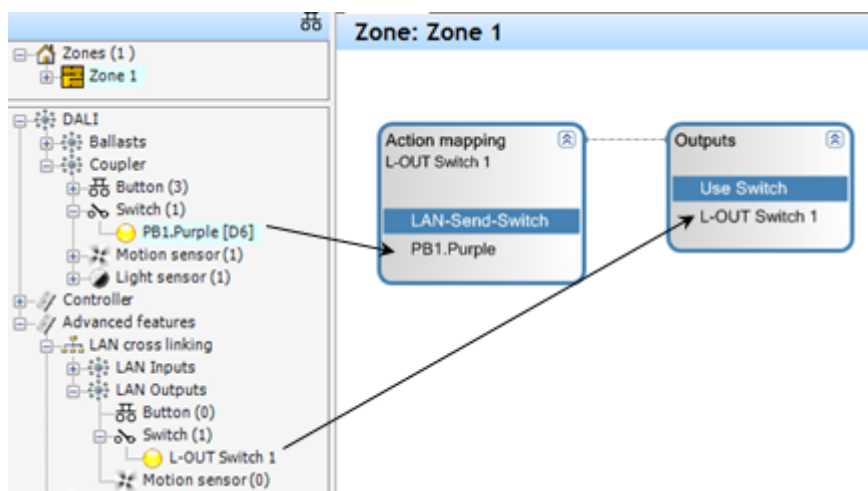

## 12.5 LAN Test Functions

The test dialog, similar to the connection dialog, can be opened via the context menu.

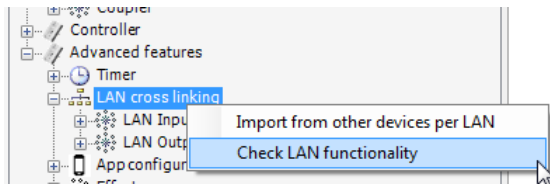

- All interconnected inputs and outputs are displayed in a tree structure.
- The properties of the selected device are shown.

**Input functions** can be simulated. For button inputs, a long push is simulated with a long click on the button.

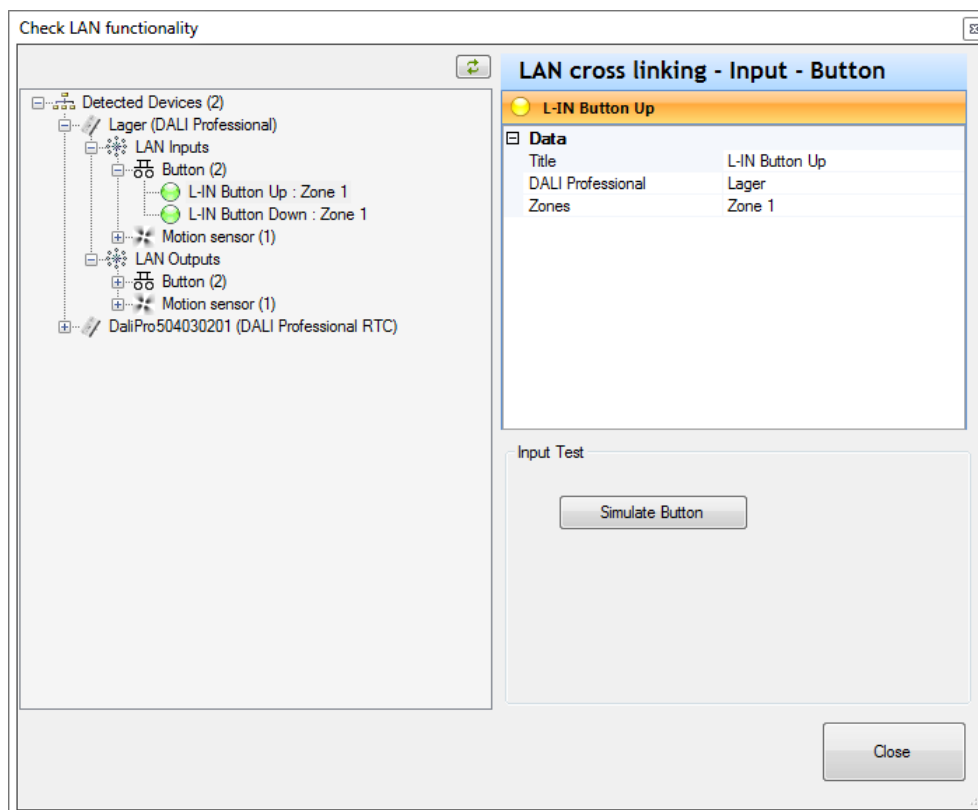

### Output Monitoring

- Messages received from outputs are recorded from the moment the test dialog opens.
- The data is displayed in a table, organized by output, with each entry including a **timestamp**.

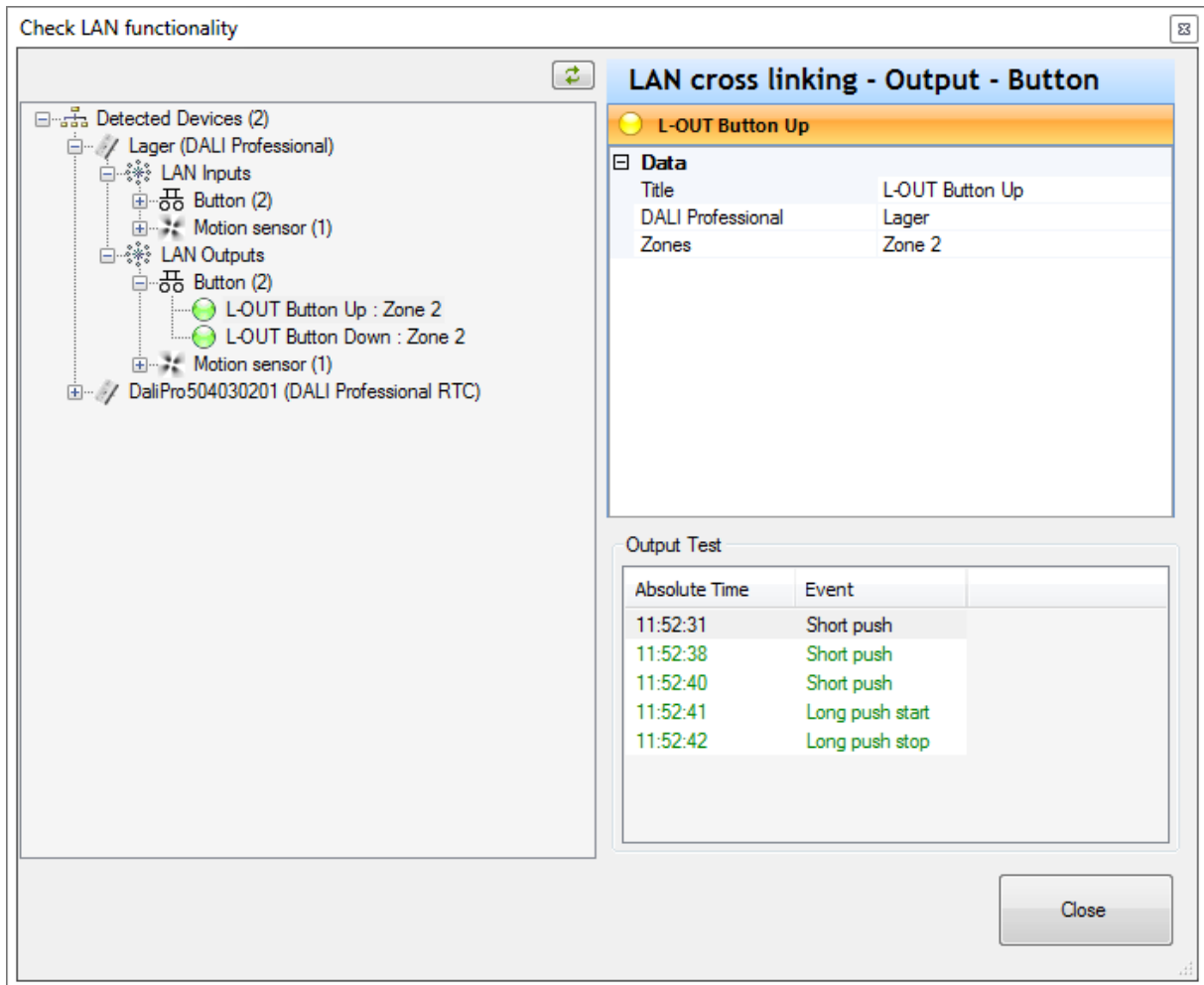

## 12.6 Auto generation or import of inputs and outputs

The import dialog, similar to the connection or test dialog, can be opened via the context menu.

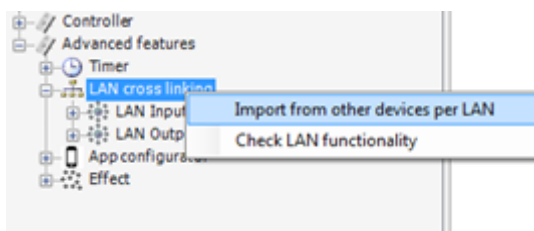

- All interconnected inputs and outputs are displayed in a tree structure.
- The properties of the selected device are shown.

When selecting an input or output from another controller, the system can **automatically generate a connection**, including creating the necessary local device.

### Example

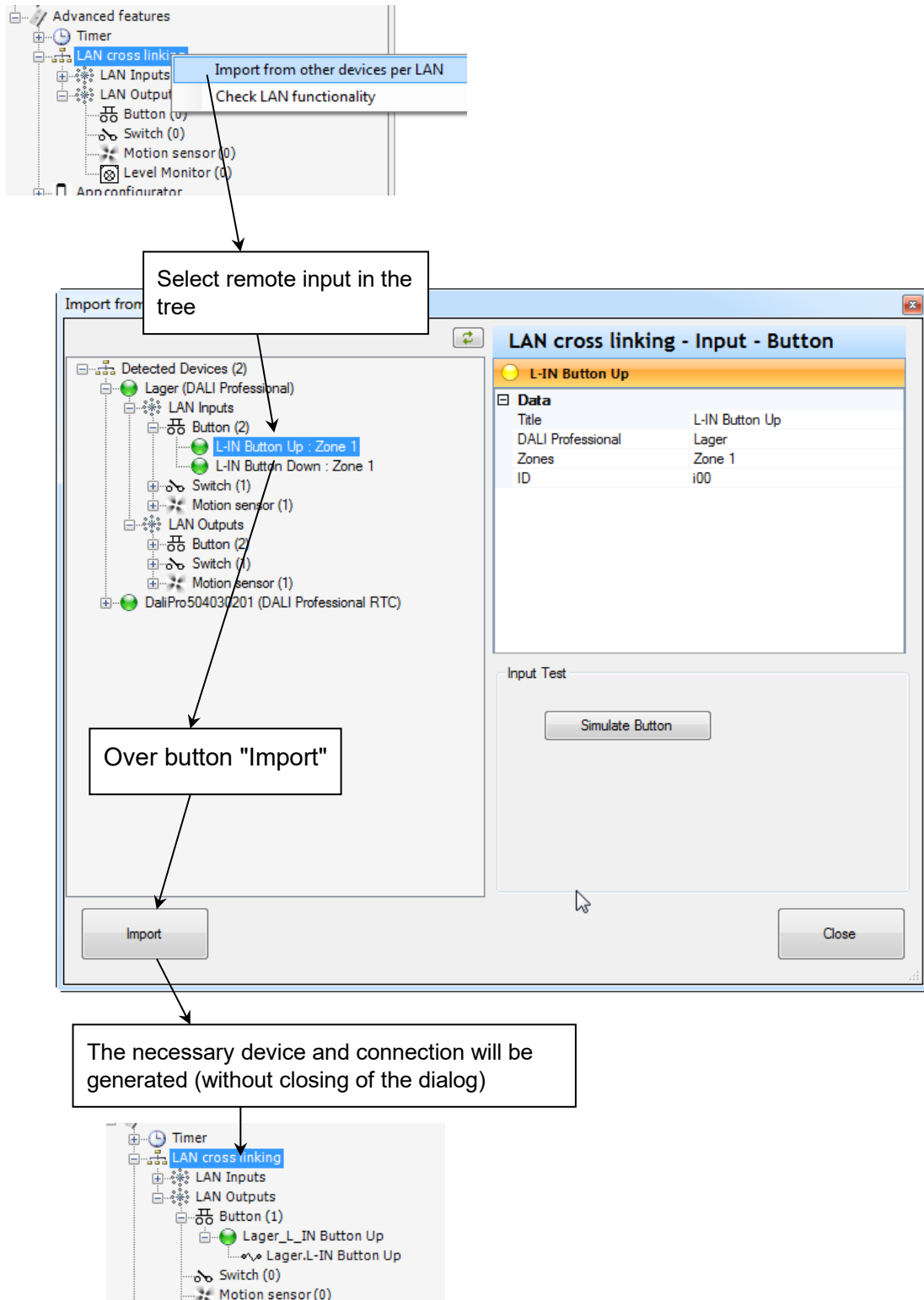

To connect to a remote input, the system can automatically generate a **button output**, simplifying the configuration process and ensuring correct connections.

## 13 Emergency Light

Connect to the controller and right click on "ECG" to open the Emergency Light feature window.

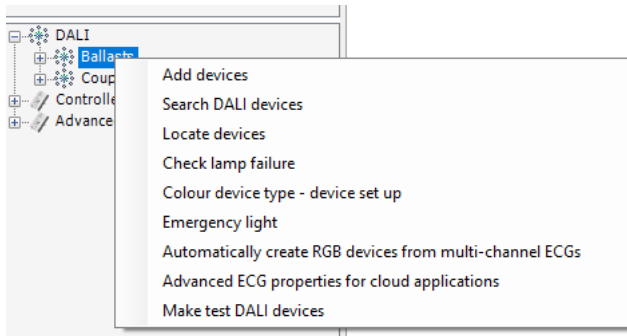

The EL window will appear, containing 4 different Tabs:

### 13.1 State

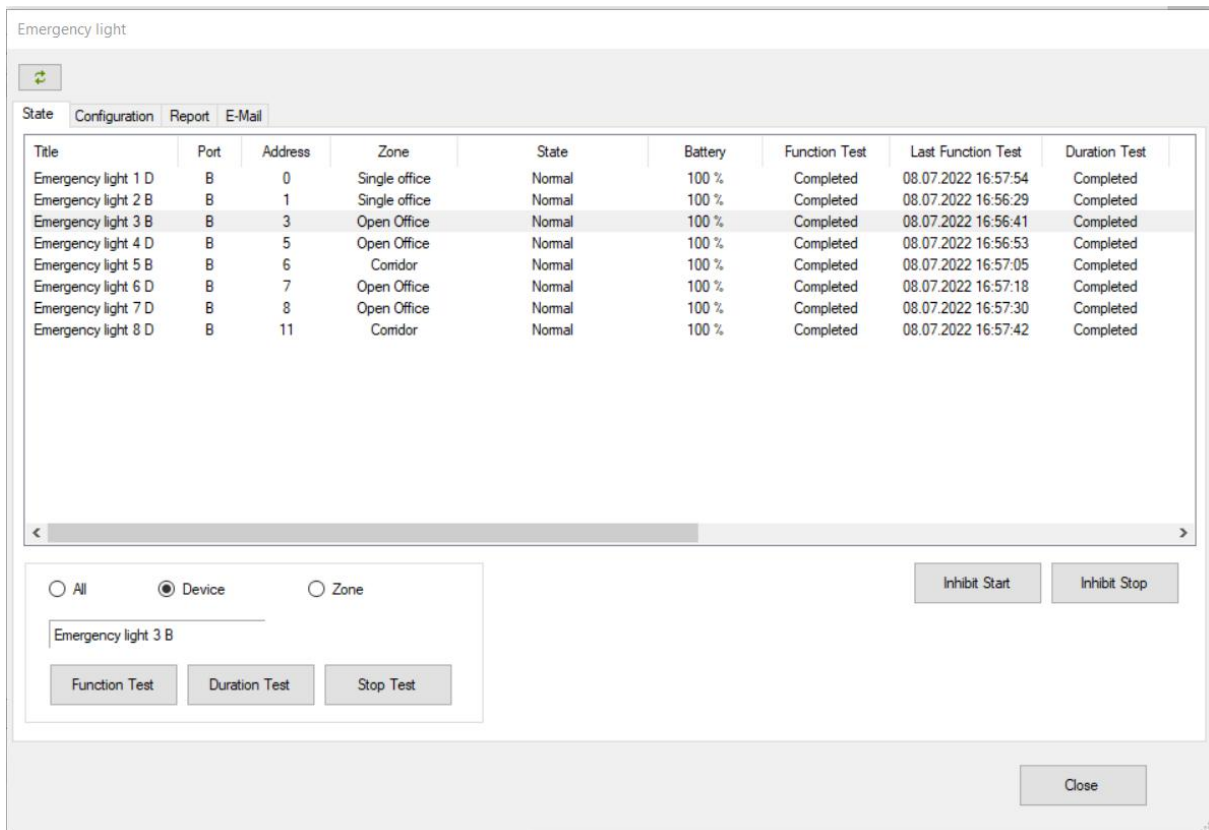

An overview of the EL installation is provided here, containing following information:

- Device name
- Port (the DALI line the EL device is connected to)
- DALI Address
- Zone
- State (see description in page...)
- Battery level

- Function Test result (see description in page...)
- Last Function Test date
- Duration Test result (see description in page...)

You can trigger a function or a duration test on a luminaire, a zone or all devices with the respective buttons below the table.

The screenshot shows a software interface titled "Emergency light". It features a navigation bar with "State", "Configuration", "Report", and "E-Mail" tabs. Below the navigation bar is a table with the following columns: State, Battery, Function Test, Last Function Test, Duration Test, Result, Last Duration Test, and Errors. The table contains 8 rows of data, all showing "Normal" state and "Completed" test results. Below the table, there are radio buttons for "All", "Device", and "Zone" (selected), a dropdown menu set to "Single office", and buttons for "Function Test", "Duration Test", and "Stop Test". To the right of these controls are "Inhibit Start" and "Inhibit Stop" buttons. A "Close" button is located at the bottom right of the interface.

State	Battery	Function Test	Last Function Test	Duration Test	Result	Last Duration Test	Errors
Normal	100 %	Completed	08.07.2022 16:57:54	Completed	3:00:00	08.07.2022 20:45:37	
Normal	100 %	Completed	08.07.2022 16:56:29	Completed	3:00:00	08.07.2022 20:06:17	
Normal	100 %	Completed	08.07.2022 16:56:41	Completed	3:00:00	08.07.2022 20:06:29	
Normal	100 %	Completed	08.07.2022 16:56:53	Completed	3:00:00	08.07.2022 20:44:48	
Normal	100 %	Completed	08.07.2022 16:57:05	Completed	3:00:00	08.07.2022 20:06:41	
Normal	100 %	Completed	08.07.2022 16:57:18	Completed	3:00:00	08.07.2022 20:45:00	
Normal	100 %	Completed	08.07.2022 16:57:30	Completed	3:00:00	08.07.2022 20:45:13	
Normal	100 %	Completed	08.07.2022 16:57:42	Completed	3:00:00	08.07.2022 20:45:25	

### 13.1.1 Inhibit Mode

This mode inhibits a device from entering emergency mode upon normal supply failure and is disabled after a pre-configured time of uninterrupted normal supply. This is especially useful in new projects, to avoid battery wear-out, due to the frequent power supply interruptions in the installation phase. Similarly, if the power needs to be turned off for maintenance reasons e.g., luminaire replacement, activating this feature will prevent the emergency mode.

The DALI PRO 2 IoT user can activate or disable the inhibit mode via the respective buttons in the PC Tool.

### 13.2 Test Configuration

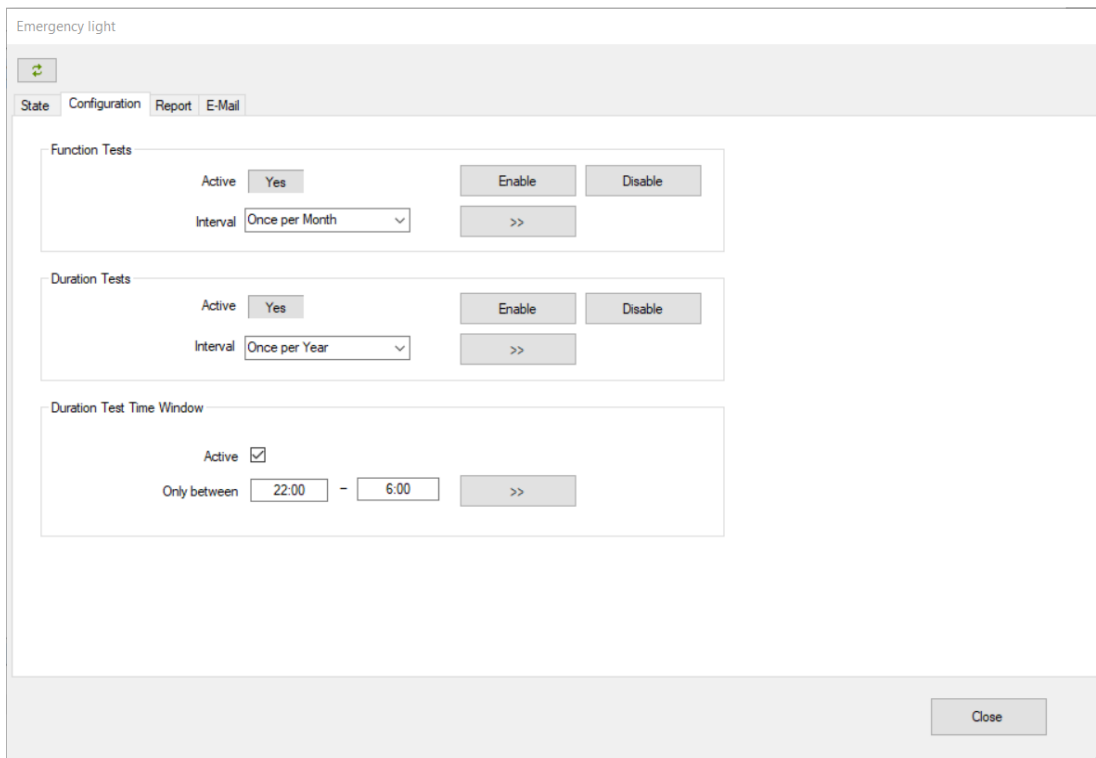

Here you can enable or disable the automatic tests, define the interval for the automatic tests, as well as the time window during which the duration test should take place. EL Report

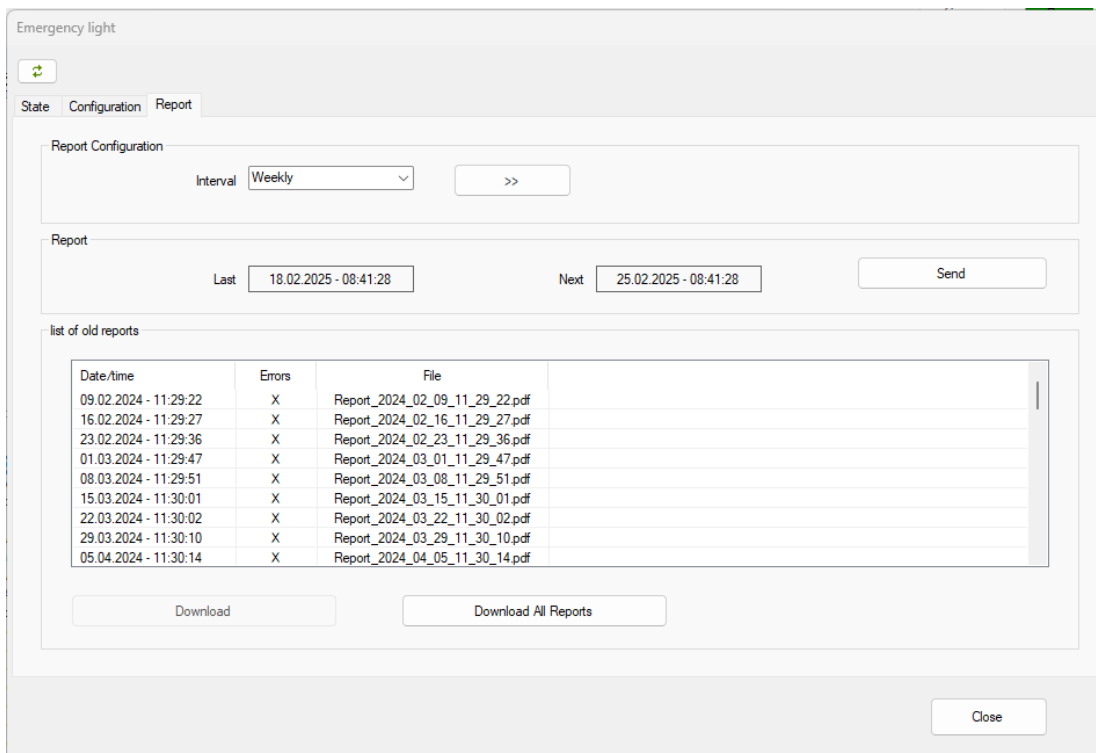

Here you can define the time intervals for the report emails. You also have an overview of the past reports, which you can select and download.

### 13.3 Email configuration

To manage email notifications, select the controller in the device tree and click on the System Settings button (1). This opens a popup window with multiple tabs.

In the **Email** tab, you can:

**Define, add, and remove** email recipients for error notifications (for the general or emergency lighting).

**Assign an administrator** responsible for managing subscriptions.

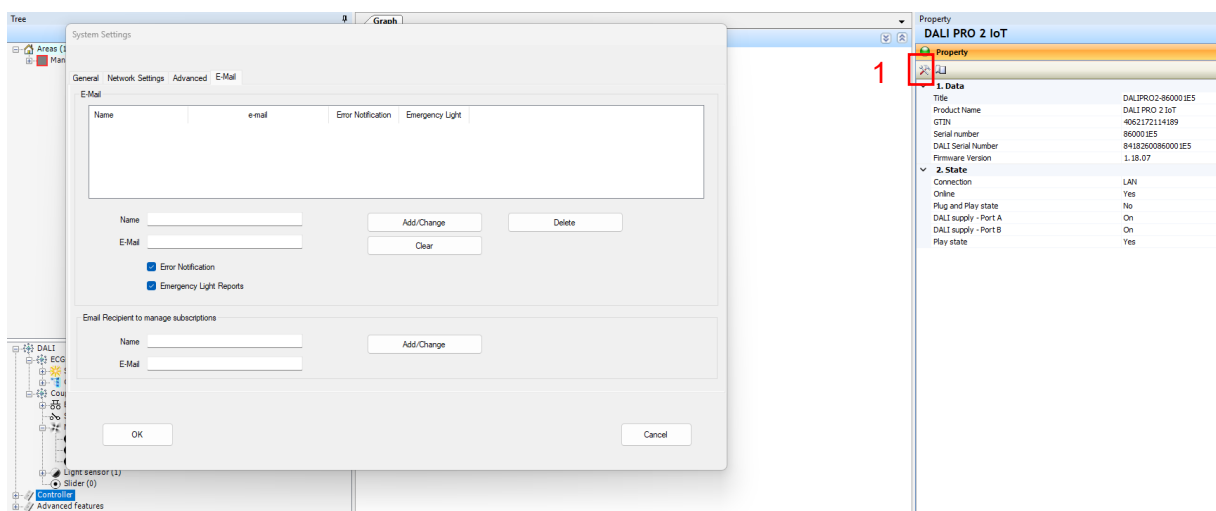

## 14 Test Functions

### 14.1 Group light status

You can check the **light level status** of the luminaires in your installation by **right-clicking** on the controller in the **device tree** and selecting **"Group Light Status"**.

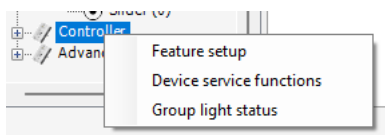

This will open a table displaying all luminaires along with details such as Zone, ID, current level, etc. By selecting a luminaire, a slider (or a color wheel for RGB/TW devices) will appear, allowing you to adjust the brightness or color in real-time— without interrupting the controller's normal operation.



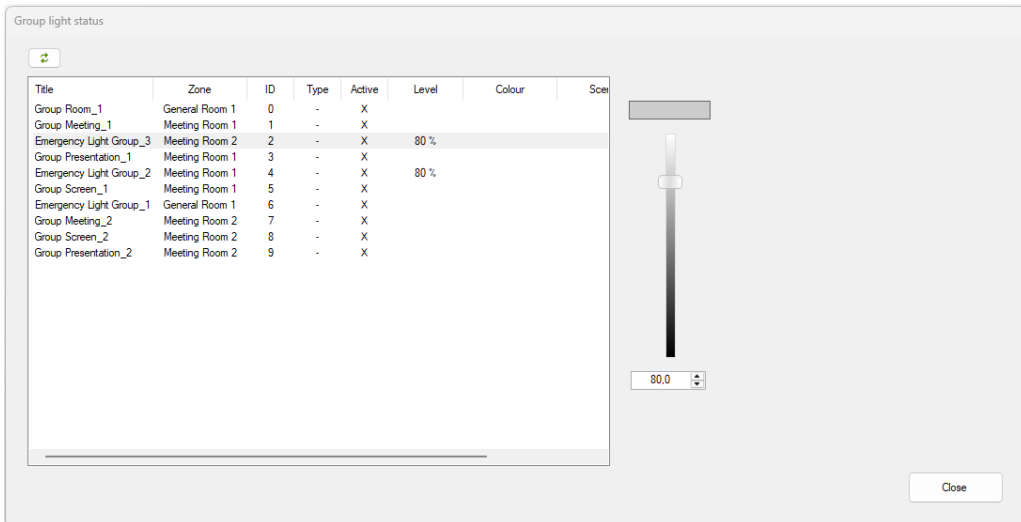

## 14.2 ECG

### Testing

#### Luminaire Functions

To test a luminaire's function, select an individual ECG and navigate to the **Device Test** tab.

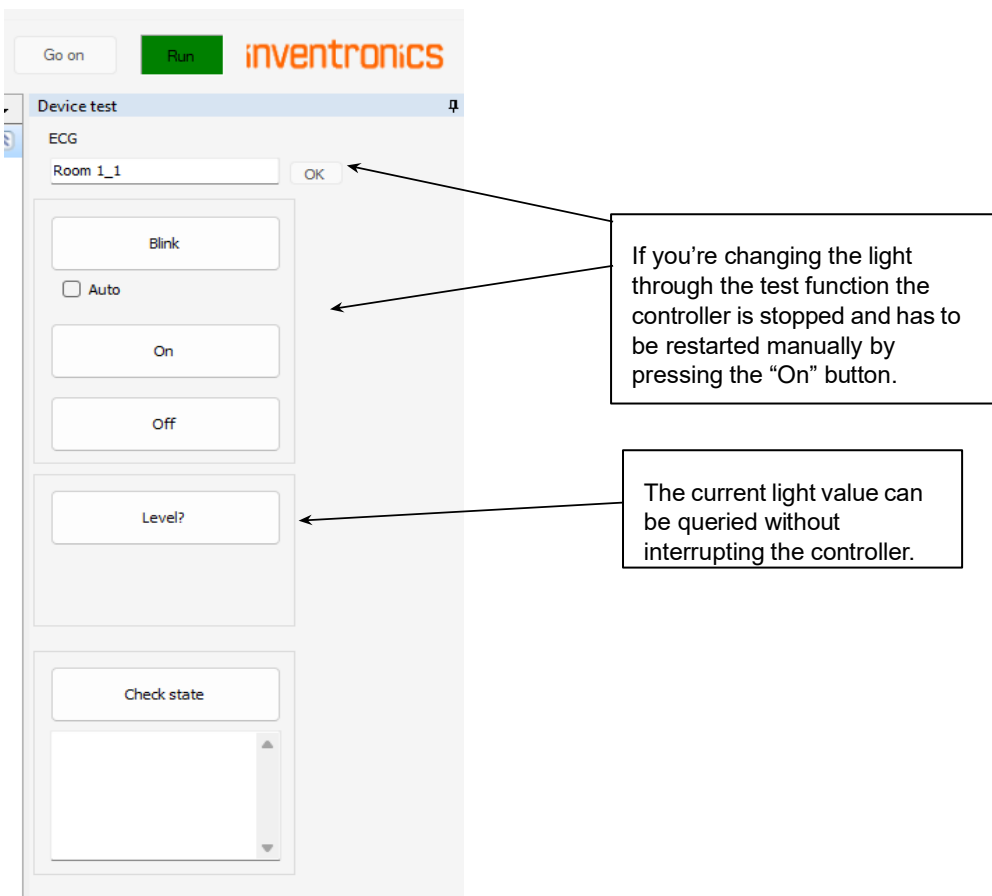

functions include:

- Turning the light On or Off.
- Querying the current light level.

The basic test

- Activating the flashing function.
- Renaming the device.

Testing automatically stops when you select another device or resume normal system operation by pressing **Go On**.

### Group Testing

When an ECG group is selected, all associated lights will flash when the blink test function is activated.

By selecting the main node for the ECG in the device tree, you can switch all connected ECGs On or Off simultaneously. Additionally, the following actions are available:

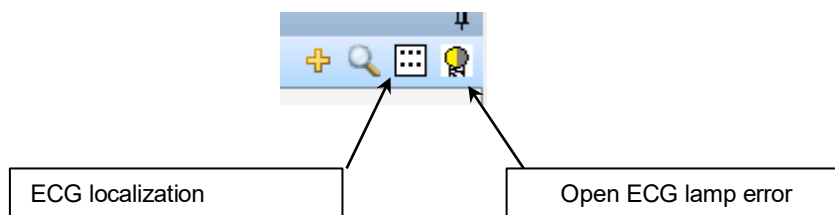

### 14.3 ECG lamp failure dialog

By opening the ECG lamp failure dialog, all ECGs will be checked for lamp errors and the respective results will be shown. By the press of the button **Scan again**, the test can be repeated. Typically, the ECG can only detect the lamp error if the lamp is on. You can click the button **All lamps on** to switch them on.

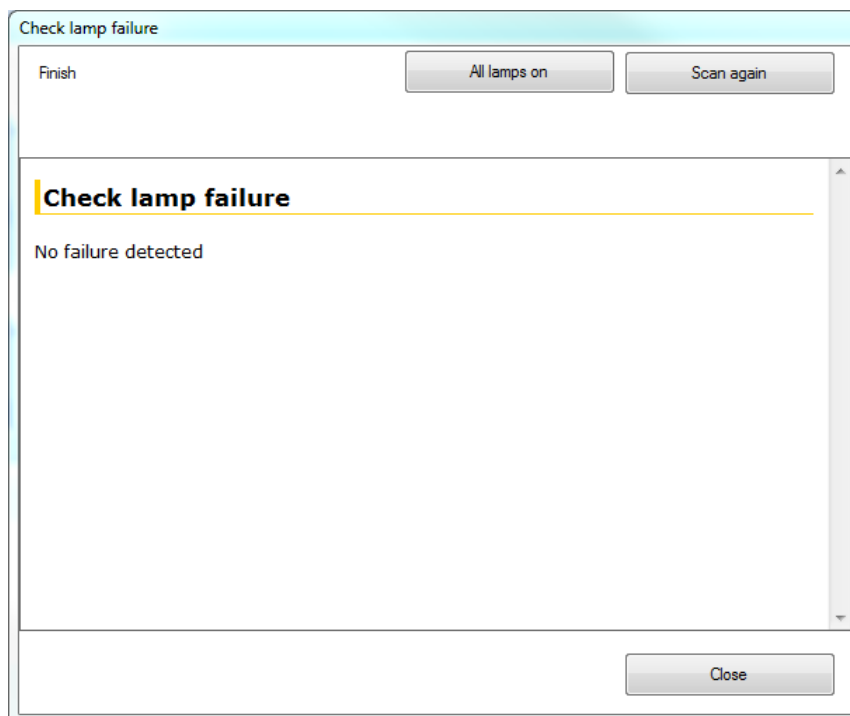

## 14.4 Device service functions

Right-click on the controller in the device tree and select "Device Service Functions" to view a summary of all identified errors in the system.

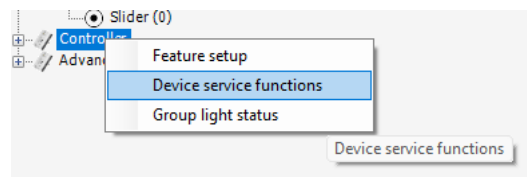

- In the **General Lighting** installation, 3 error types are identified:
  - Lamp failure
  - Driver failure
  - Communication failure
- In the **Emergency Lighting** installation, the system reports failures related to:
  - Function tests
  - Duration tests

Device Service Funktionen

Ballast
  Coupler OSRAM
  Coupler DALI 2

Error

Title	Zone	Port	Short addr...	GTIN	Product name	Error	Emergency error
Room 1_1	Gener...	A	4	4008321964403	OT 65/220-240/24 3DIM E	Lamp failure	
Meeting 1_1	Meeti...	A	0	5060203772239		Device not reachable	Duration test failed, Function test outd...
Ballast 3_1	Meeti...	A	5	5060203772239		Device not reachable	Duration test failed, Function test outd...
Presentation 1_1	Meeti...	A	7	5060203772239		Device not reachable	Function test failed, Function test outd...
Ballast 2_1	Meeti...	A	8	5060203771768		Device not reachable	Function test outdated
Screen 1_1	Meeti...	A	11	5060203772239		Device not reachable	Duration test failed, Function test outd...

Close

### 14.5 Coupler check

By selecting an individual input in the tree, device type-dependent test functions are possible in the device test panel. The test is ended by selecting any other device.

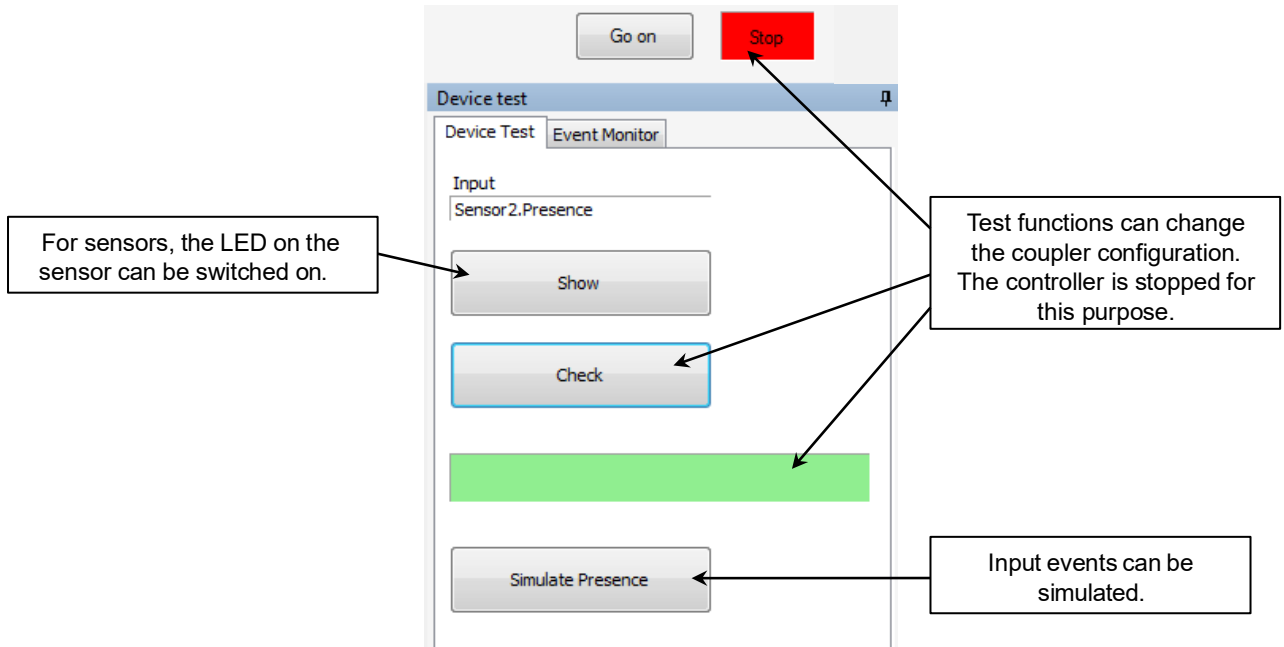

### 14.6 Check of light sensors

The light sensor check dialog can be opened using the icon. All current sensor light values are displayed in this dialog.

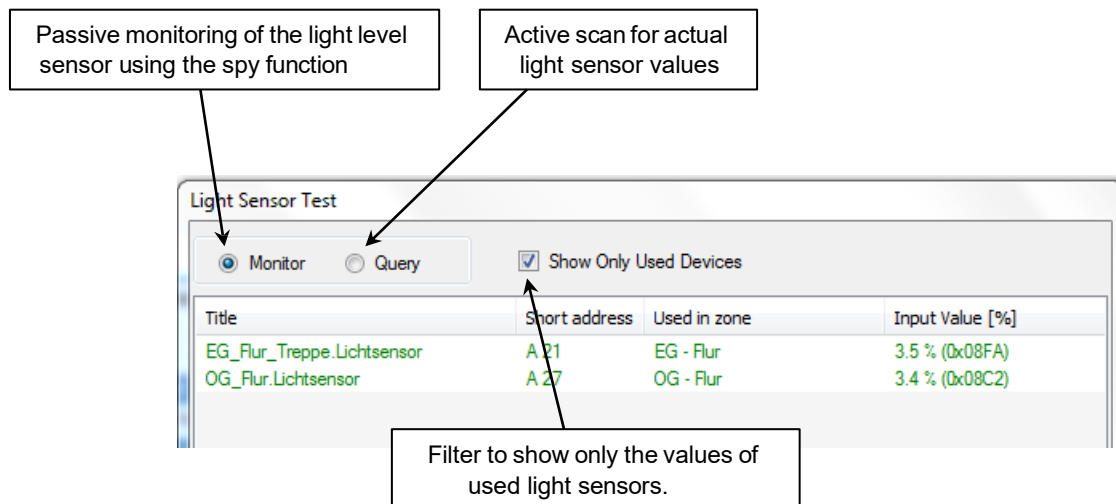

### 14.7 Event Monitor

Messages from event-generating inputs (buttons, motion sensors) can be visualised in the event monitor.

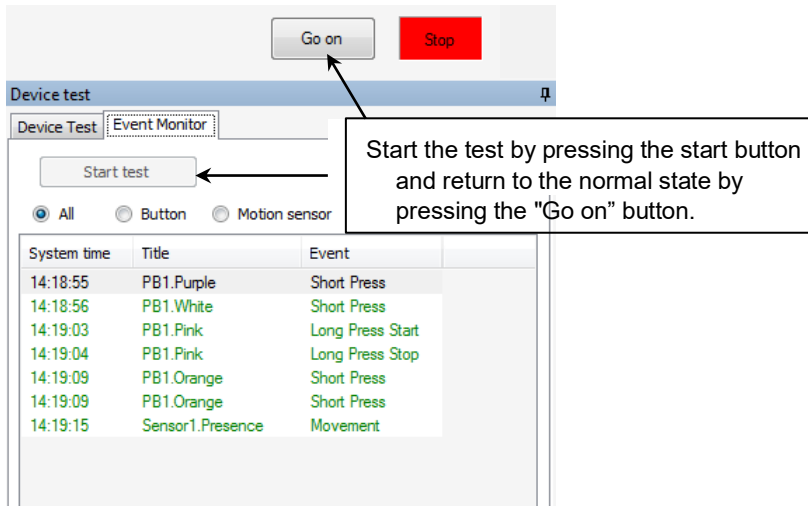

The date in the list can be deleted by opening the context menu in the list (by right-clicking) and selecting 'Delete'.

## 15 DALI SPY

**DALI Spy** is an advanced diagnostic and monitoring tool integrated into the DALI PRO controller, designed to capture, analyze, and record DALI bus communication in real time. It provides users with a detailed view of system commands, responses, and events, enabling efficient troubleshooting, commissioning, and system optimization. With features like real-time live monitoring, file-based analysis, customizable filters, and structured data export, **DALI Spy** offers a clear visualization of the DALI bus activity, empowering you to detect errors and ultimately improve the reliability and efficiency of your lighting installation.

### 15.1 DALI Spy panel

The DALI Spy panel is divided into three sections. At the top of the panel is a button bar and below that is an information bar. The bottom part of the panel contains a display area with the 'Live View' and 'File Analysis' tabs.

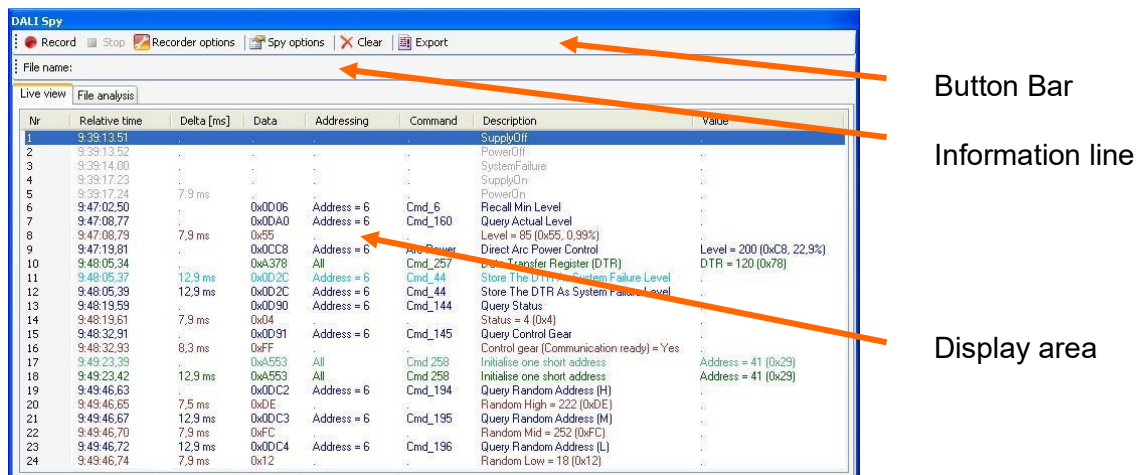

### 15.1.1 Button bar

Depending on the tab selected, the button bar contains a number of buttons, which are described below in alphabetical order.

- **“Clear” button:**  
Clears the contents of the currently selected tab display area. The button does not affect recording to a data file.
- **“Export” button:**  
Allows the contents of the selected tab to be saved to a .csv file for further processing in other programs.
- **“Open file” button:**  
Allows a data file to be opened in the display area of the File Analysis tab.
- **“Record” button:**  
Starts recording the DALI communication of the selected Magic to a data file. The file name and location of the data file can be defined in the 'Recorder options'. Each time recording is started, an automatically generated index is added to the file name. When recording is running, "(Recording running)" is displayed after the panel name. Irrespective of the filter settings, the entire communication is recorded in the data file.
- **“Recorder options” button:**  
Opens the Recorder Options dialogue box. The file path for the storage location of the data file can be specified by clicking on Path. The specified file path is shown in abbreviated form in the 'path' display field. The full path is shown in the tooltip when the cursor is over the field. The file name can be specified in the File name input box. The default file name is "dali". Clicking the Date button will append the current date to the file name.
- **“Spy Options” button:**  
Opens the Spy Options dialogue box with the Columns and Filter tabs. The tabs in the dialogue box are described in the 'Filter' or 'Columns' sections of this chapter.

### 15.1.2 Information line

When the 'Live View' tab is active, the 'File Name' is displayed in the information line of the Bus Logging panel, followed by the abbreviated path and the full file name of a data file of the current or last recording. If the cursor is on the information line, the full path and filename are displayed in the tooltip.

If the 'File analysis' tab is active, the 'File name' is displayed in the information line of the Bus Logging panel, followed by the abbreviated path and the full file name of the data file displayed in the display area. If the cursor is on the information line, the full path and file name are displayed in the tooltip.

### 15.1.3 Display Area

The DALI communication is shown in tabular form on the display area of the tab. The different command types are coded in different colors:

- System information is displayed in **GREY**.
- Addressable DALI commands that do not need to be sent twice are shown in **BLUE**.
- In the case of addressable DALI commands that need to be sent twice, the first command is shown in **LIGHT BLUE** and the second command in **BLUE**.
- Non-addressable DALI commands that do not need to be sent twice are shown in **GREEN**.
- In the case of non-addressable DALI commands that need to be sent twice, the first command is shown in **BLUE-GREEN** and the second command in **GREEN**.
- Answers to queries are shown in **RED-BROWN**.
- Unknown communication events are shown in **RED**.

An example of the color coding is shown below.

Nr	Relative time	Delta [ms]	Data	Addressing	Command	Description	Value
1	9:39:13.51					SupplyOff	
2	9:39:13.52					PowerOff	
3	9:39:14.00					SystemFailure	
4	9:39:17.23					SupplyOn	
5	9:39:17.24	7,9 ms				PowerOn	
6	9:47:02.50		0x0D06	Address = 6	Cmd_6	Recall Min Level	
7	9:47:08.77		0x0DA0	Address = 6	Cmd_160	Query Actual Level	
8	9:47:08.79	7,9 ms	0x55			Level = 85 (0x55, 0.99%)	
9	9:47:19.81		0x0CC8	Address = 6	Arc Power	Direct Arc Power Control	Level = 200 (0xC8, 22.9%)
10	9:48:05.34		0xA378	All	Cmd_257	Data Transfer Register (DTR)	DTR = 120 (0x78)
11	9:48:05.37	12,9 ms	0x0D2C	Address = 6	Cmd_44	Store The DTR As System Failure Level	
12	9:48:05.39	12,9 ms	0x0D2C	Address = 6	Cmd_44	Store The DTR As System Failure Level	
13	9:48:19.59		0x0D90	Address = 6	Cmd_144	Query Status	
14	9:48:19.61	7,9 ms	0x04			Status = 4 (0x4)	
15	9:48:32.91		0x0D91	Address = 6	Cmd_145	Query Control Gear	
16	9:48:32.93	8,3 ms	0xFF			Control gear (Communication ready) = Yes	
17	9:49:23.39		0xA553	All	Cmd_258	Initialise one short address	Address = 41 (0x29)
18	9:49:23.42	12,9 ms	0xA553	All	Cmd_258	Initialise one short address	Address = 41 (0x29)
19	9:49:46.63		0x0DC2	Address = 6	Cmd_194	Query Random Address (H)	
20	9:49:46.65	7,5 ms	0xDE			Random High = 222 (0xDE)	
21	9:49:46.67	12,9 ms	0x0DC3	Address = 6	Cmd_195	Query Random Address (M)	
22	9:49:46.70	7,9 ms	0xFC			Random Mid = 252 (0xFC)	
23	9:49:46.72	12,9 ms	0x0DC4	Address = 6	Cmd_196	Query Random Address (L)	
24	9:49:46.74	7,9 ms	0x12			Random Low = 18 (0x12)	

## 15.2 Spy Options

### 15.2.1 Columns

The Columns tab of the Spy Options dialogue box allows you to define the columns displayed in the display area.

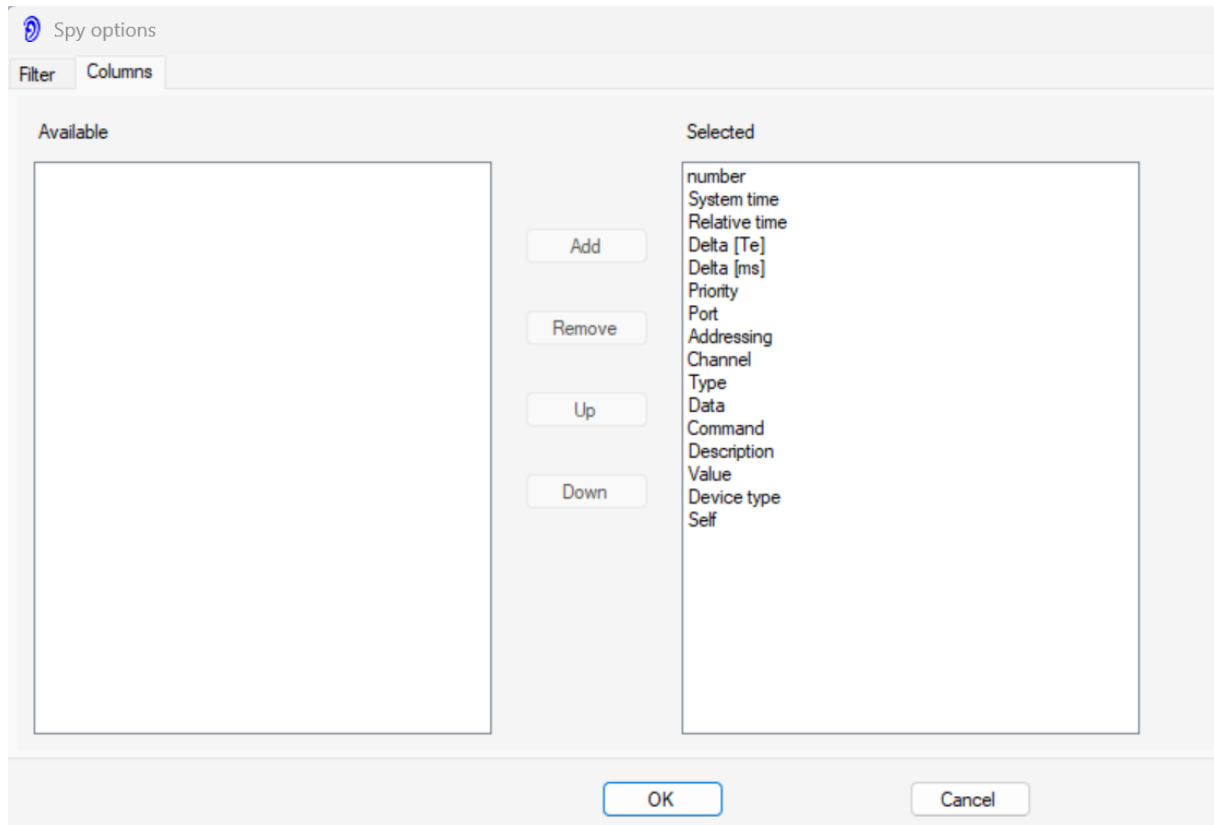

The meaning of each column is:

- **Addressing:**  
Type of addressing and address of the captured command. Non-addressable commands are marked with "All".
- **Channel:**  
This column is intended for future applications and is currently not displayed.
- **Command:**  
Command number according to IEC 62386.
- **Data:**  
Raw data recorded by the interface, displayed in hexadecimal.
- **Delta [ms]:**  
Time between the current event and the previous event in ms. If the time is greater than 106 ms, the column remains empty.
- **Delta [sec]:**



Time between the current event and the previous event in units of 417  $\mu$ s. If the time is greater than 255 units, the column remains blank.

- **Description:**  
Command name according to IEC 62386 or interpretation and value of a response.
- **Device type:**  
Descriptive text of the device type for device type specific commands.
- **Event:**  
Consecutive number of the registered event on the DALI line.
- **Priority:**  
Command priority according to IEC 62386.
- **Relative time:**  
Time at which an event was registered, measured since the DALI Magic was switched on. The format is hh:mm:ss.xy with a resolution of 10 ms.
- **Type:**  
Details of the event type: 2 byte, 3 byte, response.
- **Value:**  
Parameter value for commands containing a parameter.

The column selection is stored separately for live view and file analysis depending on the user. The column selection does not affect the recording to a data file.

### 15.2.2 Filter

A filter criterion can be defined in the Filter tab of the Spy Options dialogue box. Only items that match the filter criteria will be displayed in the display area. You can filter by address and/or command.

- **Address filter:**  
Short addresses, group addresses, broadcast or special addresses (non-addressable commands) can be selected as filter criteria. Non-addressable commands are marked with "All" in the display area.
- **Command filter:**  
The command filter provides all commands defined in IEC 62386 as filter criteria, grouped by command type. When a filter is applied, "(Filter)" is displayed behind the tab name in the DALI Spy Panel.

The filter criterion is stored separately for live view and file analysis, depending on the user. The filter criterion has no effect on recording to a data file.

If the filter criterion is not selected correctly, no element may be displayed in the display area.

## 16 Appendix

### 16.1 Create a diagnose file

While using the **PC tool**, log data is continuously generated and stored in the following directory:

**Path:** C:\Users\[Username]\Documents\Inventronics\DaliProfessional\_v3

Folder	Description
Log	Contains log data files in <b>.csv</b> format.
Spy	Stores DALI spy files from uploads or device searches when the <b>"Extended log function"</b> is enabled.
Upload	Saves copies of project files as archives for each upload. File names are automatically appended with date and time. Files with the extension <b>".osrdp2u"</b> are write-protected by the tool.

To facilitate analysis, a diagnostic ZIP file can be automatically generated, containing all stored files. This can be done via the **"About"** dialog by selecting the **Diagnose** tab and clicking the corresponding icon.

### 16.2 Device Feature

Most features are available out of the box. However, some, like the Emergency Lighting feature (free for up to 5 EL luminaires), may require activation.

To activate a feature, enter the activation key provided by Inventronics into the designated field under the Device Feature tab. This tab can be accessed via the "i" button.

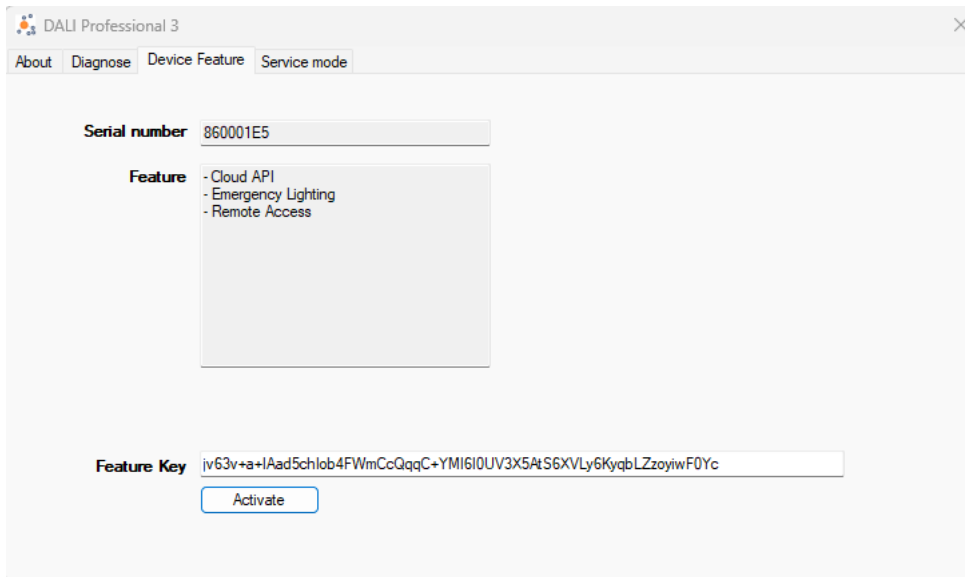

### 16.3 Set controller back to plug & play mode

The current configuration on the controller can be deleted, restoring it to **Plug & Play mode**, using the following menu function:

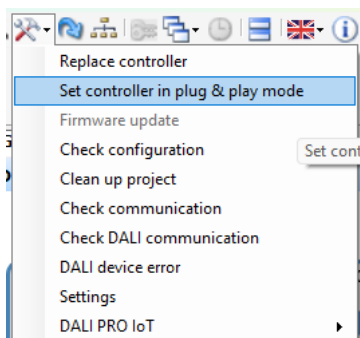

The dialog window provides options to reset the controller, as well as ECGs and couplers if needed.

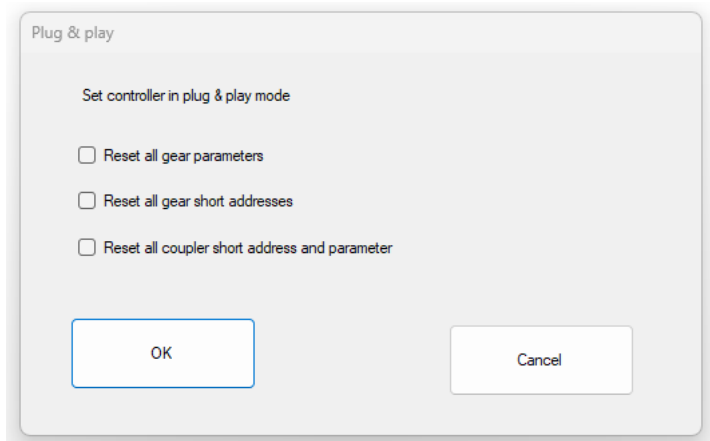

## 16.4 Remote Access

The Remote Access feature allows you to modify your DALI PRO 2 IoT Lighting System without needing an on-site visit. Adjustments are made by updating the configuration file stored on the controller. This file is typically created during the on-site commissioning process.

For more details, refer to our Remote Access Quick Start Guide, available here: [Dali Pro 2 IoT – Inventronics](#)

## 16.5 API

The DALI PRO 2 IoT supports an open MQTT and REST API interface, allowing direct integration with third-party software for system monitoring, configuration, and control. These interfaces enable bidirectional communication with external applications, making it possible to retrieve status information, adjust settings, and execute commands remotely. The API structure follows standard protocols to ensure compatibility with various platforms, including cloud services and building management systems.

For implementation details and usage instructions, refer to our API Quick Start Guides, available here: [Dali Pro 2 IoT – Inventronics](#)

Use our contact form

[www.inventronicsglobal.com/contact-us](http://www.inventronicsglobal.com/contact-us)



Service contact:  
Inventronics GmbH  
Parkring 31-33, 85748 Garching, Germany  
[www.inventronicsglobal.com](http://www.inventronicsglobal.com)  
[support@inventronicsglobal.com](mailto:support@inventronicsglobal.com)